



Home > Products > Surge Generator

Product Categories

- Goniophotometer >
- Spectroradiometer >
- Integrating Sphere >
- LED Test Instruments >
- CFL Testing Instruments >
- Photometer and Colorimeter >
- EMI and EMC Test Systems >
- Electronic Ballast Tester >
- Electrical Safety Tester >
- Environmental Test Chamber >
- Plug and Switch Testing >
- AC and DC Power Supply >
- Object Color and Glossiness Test >
- Mask Produce and Test Machine >
- Electronic Components Test >



Surge Generator

Product No: SG61000-5

Get a Quote

Your email address will not be published. Required fields are marked \*

Name\*

Company\*

Email\*

Cell/WhatsApp

Message\*

Verify Code



Send

63

Description

Video

Download

The SG61000-5 fully automatic surge generator (also called lightning surge immunity test, combination wave generator, surge cur generator/surge voltage generator, combined surge voltage and current generator) .

1

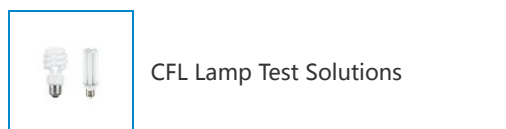
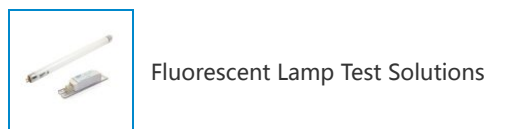
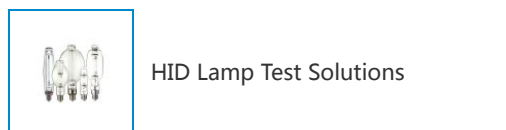
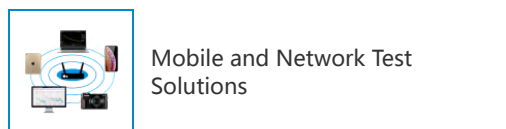
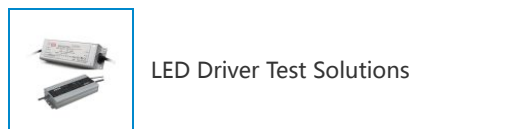
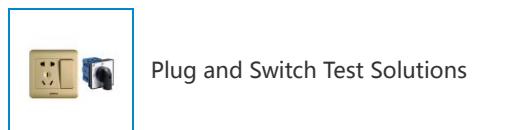
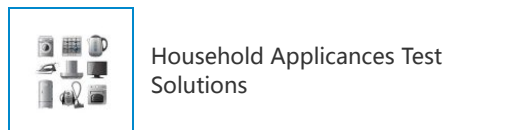
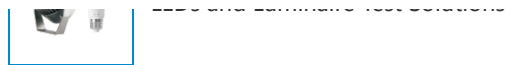

Product Model	SG61000-5SA	SG61000-5SB	SG61000-5	SG61000-5H-SP	SG61000-5T
Output Voltage (Open)	1.2/50μs±20%	1.2/50μs±20%	1.2/50μs±20%	1.2/50μs±20%	1.2/50μs±20%
Output Current (Short)	8/20μs±20%	8/20μs±20%	8/20μs±20%	8/20μs±20%	8/20μs±20%
Output Impedance	2Ω and 12Ω	2Ω and 12Ω	2Ω and 12Ω	2Ω 12Ω and 500Ω	2Ω and 12Ω
Output Voltage Range	0~4.8KV±10%	0~4.8KV±10%	0~6KV±10%	0~10KV±10%	0~6KV±10%
Output Current Range	0~2.4KA±10%	0~2.4KA±10%	0~3KA±10%	0~5KA±10%	0~3KA±10%
Surge Repetition	1~9999 times	1~9999 times	1~9999 times	1~9999 times	1~9999 times
Interval Time	20~9999s	20~9999s	20~9999s	30~9999s	20~9999s
Polarity	Positive, Negative or Positive/Negative automatic				
Phase Shift	Asynchronous, Synchronization 0°~ 360° or Specific Angle				
Special Function	N/A		Built-in High voltage and current 2000:1 attenuator probe (Less than 10KV surge generator is 1000:1), connect with LISUN <a href="#">OSP1102</a> directly		
Operation Way	Button Input		Touch screen with super big LCD and built-in Windows CE		
Dimensions (WxDxH)	44x45x35cm	44x45x35cm	44x45x35cm	56x69x155cm	44x45x55cm
Gross Weight	About 30kg	About 30kg	About 30kg	About 270kg	About 48kg
Coupling/Decoupling Network (CDN)	Includes a 16A single phase CDN				Includes a 20A 3phases CDN
Isolation Transformer for EUT (Optional)	LISUN <a href="#">ITEU-SP4K</a> (220V Single phase) or <a href="#">ITUS-SP2K</a> (110V)				LISUN <a href="#">ITEU-TP10K</a> or <a href="#">ITUS-...</a>



IEC International Electrotechnical Commission



ISO International Organization for Standardization



BIS Bureau of Indian Standards



ANSI American National Standards Institute



SASO Saudi Arabian Standards Organization



TSE Turkish Standards Institution



NOM Norma Oficial Mexicana



GB China Guo Biao



Protect Device for Surge Test PD-E01

**We suggest you choose LISUN SG-DESK Surge Generator desk to work with SG61000-5 Surge Generator and Isolation Transformer.**

Tags : [SG61000-5](#) , [SG61000-5H](#) , [Surge Generator](#)



Related Technical Articles

Led test instruments supplier in China

Lighting surge analysis and how does it work

Surge Generators for DC HiPot and Surge Tests

LISUN SG61000-5 Surge Generator – After Sales Questions and Answers

Surge test and impulse withstand voltage test work principle introduce and both test difference

Surge Generators for DC HiPot and Surge Tests

Why are Surge Generators Important

How do surge generators perform surge immunity tests

How does the surge generator avoid power surges

Are you aware of the working of a Surge Generator

Related Successful Case

India-The customer successfully installed and operated the LPCE-3 compact



SG-DESK Surge Generator Desk

What is a combination wave?

A Combination Wave Generator (CWG) sends a voltage impulse into an open circuit while also delivering a current impulse into a short circuit to mimic both of these situations. The SG61000-5 Surge Generator's combination wave is 1.2/50us and 8/20us as below:

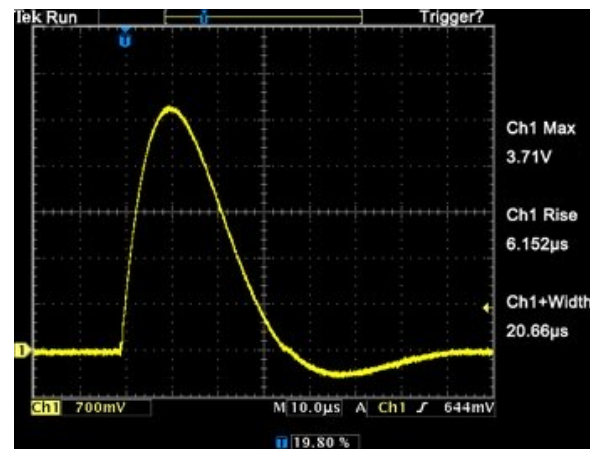

6KV Short Circuit Current Output Waveform (780:1)

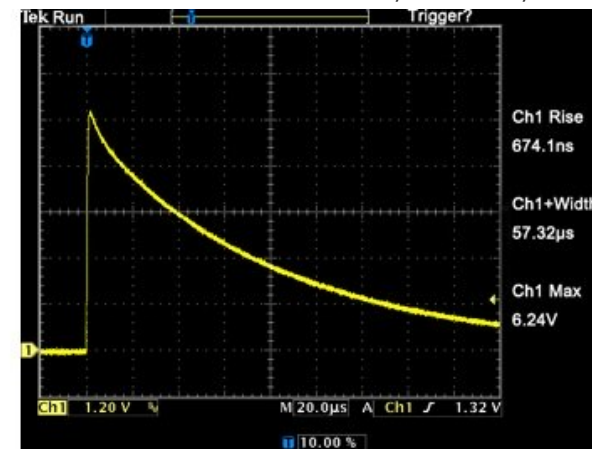

6KV Open Circuit Voltage Output Waveform (1000:1)

**BRITISH STANDARD**

**61000-4-5:1995**

**IEC**

**61000-4-5:1995**

*Incorporating  
Amendment Nos. 1 and 2*

# Electromagnetic compatibility (EMC) —

## Part 4-5: Testing and measurement techniques — Surge immunity test

[www.LisunGroup.com](http://www.LisunGroup.com)

The European Standard EN 61000-4-5:1995, with the incorporation of amendment A1:2001, has the status of a British Standard

ICS.33.100.20

**NO COPYING WITHOUT BSI PERMISSION EXCEPT AS PERMITTED BY COPYRIGHT LAW**



## Committees responsible for this British Standard

The preparation of this British Standard was entrusted to Technical Committee GEL/110, Electromagnetic compatibility, upon which the following bodies were represented:

Association of Consulting Scientists  
 Association of Control Manufacturers [TACMA (BEAMA Ltd.)]  
 Association of Manufacturers of Domestic Electrical Appliances  
 Association of Manufacturers of Power Generating Systems and Association of British Generating Set Manufacturers  
 BEAMA Ltd.  
 BEAMA Metering Association (BMA)  
 British Industrial Truck Association  
 British Lighting Association for the Preparation of Standards (BRITLAPS)  
 British Telecommunications plc.  
 Building Automation and Mains Signalling Association (BAMSA) (BEAMA Ltd.)  
 Department of Health  
 Department of Trade and Industry (National Physical Laboratory)  
 Department of Trade and Industry (Standards Policy Unit)  
 Electrical Installation Equipment Manufacturers' Association (BEAMA Ltd.)  
 Electricity Association  
 ERA Technology Ltd.  
 Federation of the Electronics Industry  
 GAMBICA (BEAMA Ltd.)  
 Health and Safety Executive  
 Induction and Dielectric Heating Manufacturers' Association  
 Institution of Electrical Engineers  
 Lighting Industry Federation Ltd.  
 Ministry of Defence  
 National Air Traffic Services  
 Power Supply Manufacturers' Association [PSMA (BEAMA Ltd.)]  
 Professional Lighting and Sound Association  
 Radiocommunications Agency  
 Rotating Electrical Machines Association (BEAMA Ltd.)  
 Society of British Gas Industries  
 Society of Motor Manufacturers and Traders Ltd.  
 Transmission and Distribution Association (BEAMA Ltd.)

This British Standard, having been prepared under the direction of the Electrotechnical Sector Board, was published under the authority of the Standards Board and comes into effect on 15 September 1995

© BSI 11 September 2001

The following BSI references relate to the work on this standard:  
 Committee reference GEL/110  
 Draft for comment 90/21076 DC

ISBN 0 580 24746 5

### Amendments issued since publication

Amd. No.	Date	Comments
9128	September 1996	Correction of titles of Figure 6 and Figure 7
13146	11 September 2001	See national foreword

## Contents

	Page
Committees responsible	Inside front cover
National foreword	ii
Foreword	2
Text of EN 61000-4-5	5

www.Lisungroup.com



## National foreword

This British Standard has been prepared by Technical Committee GEL/110 and is the English language version of EN 61000-4-5 *Electromagnetic compatibility (EMC) — Part 4-5: Testing and measurement techniques — Surge immunity tests* including amendment A1:2001, published by the European Committee for Electrotechnical Standardization (CENELEC). It is identical with IEC 61000-4-5:1995, including amendment 1:2000, published by the International Electrotechnical Commission (IEC).

The start and finish of text introduced or altered by amendment is indicated in the text by tags **A1)** **A1]**. Tags indicating changes to IEC text carry the number of the IEC amendment. For example, text altered by IEC amendment 1 is indicated by **A1)** **A1]**.

From 1 January 1997, all IEC publications have the number 60000 added to the old number. For instance, IEC 27-1 has been renumbered as IEC 60027-1. For a period of time during the change over from one numbering system to the other, publications may contain identifiers from both system.

### Cross-references

The British Standards which implement these international or European publications may be found in the BSI Standards Catalogue under the section entitled "International Standards Correspondence Index", or by using the "Find" facility of the BSI Standards Electronic Catalogue.

A British Standard does not purport to include all the necessary provisions of a contract. Users of British Standards are responsible for their correct application.

**Compliance with a British Standard does not of itself confer immunity from legal obligations.**

### Summary of pages

This document comprises a front cover, an inside front cover, pages i and ii, the EN title page, pages 2 to 31 and a back cover.

The BSI copyright notice displayed in this document indicates when the document was last issued.



**EUROPEAN STANDARD**  
**NORME EUROPÉENNE**  
**EUROPÄISCHE NORM**

March 1995

**+ A1**

February 2001

ICS 29.020

Including corrigendum October 1995

Descriptors: Electromagnetic compatibility, electric equipment, electronic equipment, tests, shock waves, overvoltage, testing conditions

English version

**Electromagnetic compatibility (EMC) —**  
**Part 4-5: Testing and measurement techniques —**  
**Surge immunity test**

(includes amendment A1:2001)  
(IEC 61000-4-5:1995 + A1:2000)

Compatibilité électromagnétique (CEM) —  
Partie 4-5: Techniques d'essai et de mesure —  
Essai d'immunité aux ondes de choc  
(inclut l'amendement A1:2001)  
(CEI 61000-4-5:1995 + A1:2000)

Elektromagnetische Verträglichkeit (EMV) —  
Teil 4-5: Prüf- und Meßverfahren —  
Prüfung der Störfestigkeit gegen  
Stoßspannungen  
(enthält Änderung A1:2001)  
(IEC 61000-4-5:1995 + A1:2000)

This European Standard was approved by CENELEC on 1995-03-06. Amendment A1 was approved by CENELEC on 2000-12-01. CENELEC members are bound to comply with the CEN/CENELEC Internal Regulations which stipulate the conditions for giving this European Standard the status of a national standard without any alteration.

Up-to-date lists and bibliographical references concerning such national standards may be obtained on application to the Central Secretariat or to any CENELEC member.

This European Standard exists in three official versions (English, French, German). A version in any other language made by translation under the responsibility of a CENELEC member into its own language and notified to the Central Secretariat has the same status as the official versions.

CENELEC members are the national electrotechnical committees of Austria, Belgium, Denmark, Finland, France, Germany, Greece, Iceland, Ireland, Italy, Luxembourg, Netherlands, Norway, Portugal, Spain, Sweden, Switzerland and United Kingdom.

**CENELEC**

European Committee for Electrotechnical Standardization  
Comité Européen de Normalisation Electrotechnique  
Europäisches Komitee für Elektrotechnische Normung

**Central Secretariat: rue de Stassart 35, B-1050 Brussels**

© 1995 Copyright reserved to CENELEC members

Ref. No. EN 61000-4-5:1995 + A1:2001 E

## Foreword

The text of document 65A/77B(CO)41/25, future edition 1 of IEC 1000-4-5, prepared by SC 65A, System aspects, of IEC TC 65, Industrial-process measurement and control, was submitted to the IEC-CENELEC parallel vote and was approved by CENELEC as EN 61000-4-5 on 1995-03-06.

The following dates were fixed:

- latest date by which the EN has to be implemented at national level by publication of an identical national standard or by endorsement (dop) 1996-03-01
- latest date by which the national standards conflicting with the EN have to be withdrawn (dow) 1996-03-01

Annexes designated “normative” are part of the body of the standard. Annexes designated “informative” are given for information only. In this standard, Annex A and Annex ZA are normative and Annex B and Annex C are informative. Annex ZA has been added by CENELEC.

## Foreword to amendment A1

The text of documents 77B/291+293/FDIS, future amendment 1 to IEC 61000-4-5:1995, prepared by SC 77B, High-frequency phenomena, of IEC TC 77, Electromagnetic compatibility, was submitted to the IEC-CENELEC parallel vote and was approved by CENELEC as amendment A1 to EN 61000-4-5:1995 on 2000-12-01.

The following dates were fixed:

- latest date by which the amendment has to be implemented at national level by publication of an identical national standard or by endorsement (dop) 2001-09-01
- latest date by which the national standards conflicting with the amendment have to be withdrawn (dow) 2003-12-01

## Contents

	Page
Foreword	2
Introduction	5
1 Scope and object	5
2 Normative references	6
3 General	6
3.1 Switching transients	6
3.2 Lightning transients	6
3.3 Simulation of the transients	6
4 Definitions	6
5 Test levels	8
6 Test instrumentation	9
6.1 Combination wave (hybrid) generator (1,2/50 $\mu$ s – 8/20 $\mu$ s)	9
6.2 Test generator 10/700 $\mu$ s according to CCITT	9
6.3 Coupling/decoupling networks	10
7 Test set-up	12
7.1 Test equipment	12
7.2 Test set-up for tests applied to EUT power supply	12
7.3 Test set-up for tests applied to unshielded unsymmetrically operated interconnection lines	12
7.4 Test set-up for tests applied to unshielded symmetrically operated interconnection/telecommunication lines (Figure 12)	12
7.5 Test set-up for tests applied to shielded lines	13
7.6 Test set-up to apply potential differences	13
7.7 Other test set-ups	13
7.8 Test conditions	13
8 Test procedure	13
8.1 Laboratory reference conditions	13
8.2 Application of the surge in the laboratory	14
9 $\square$ Evaluation of test results	14
10 Test report $\square$	15
Annex A (normative) Selection of generators and test levels	26
Annex B (informative) Explanatory notes	27
Annex C (informative) Bibliography	30
Annex ZA (normative) Other international publications quoted in this standard with the references of the relevant European publications	31

	Page		Page
Figure 1 — Simplified circuit diagram of the combination wave generator	15	Figure B.3 — Example for primary and secondary surge protection of indoor-outdoor equipment	30
Figure 2 — Waveform of open-circuit voltage (1,2/50 $\mu$ s)	16	Table 1 — Test levels	8
Figure 3 — Waveform of short-circuit current (8/20 $\mu$ s)	17	Table 2 — Definitions of the waveform parameters 1,2/50 $\mu$ s	16
Figure 4 — Simplified circuit diagram of the 10/700 $\mu$ s impulse generator	17	Table 3 — Definitions of the waveform parameters 10/700 $\mu$ s	18
Figure 5 — Waveform of open-circuit voltage (10/700 $\mu$ s)	18	Table A.1 — Selection of the test levels (depending on the installation conditions)	26
Figure 6 — Example of test set-up for capacitive coupling on a.c./d.c. lines; line-to-line coupling (according to 7.2)	19		
Figure 7 — Example of test set-up for capacitive coupling on a.c./d.c. lines; line-to-earth coupling (according to 7.2)	19		
Figure 8 — Example of test set-up for capacitive coupling on a.c. lines (3 phases); line L3 to line L1 coupling (according to 7.2)	20		
Figure 9 — Example of test set-up for capacitive coupling on a.c. lines (3 phases); line L3 to earth coupling (according to 7.2), generator output earthed	21		
Figure 10 — Example of test set-up for unshielded interconnection lines; line-to-line/line-to-earth coupling (according to 7.3), coupling via capacitors	22		
Figure 11 — Example of test set-up for unshielded unsymmetrically operated lines; line-to-line/line-to-earth coupling (according to 7.3), coupling via arrestors	23		
Figure 12 — Example of test set-up for unshielded symmetrically operated lines (telecommunication lines); line-to-line/line-to-earth coupling (according to 7.4), coupling via arrestors	24		
Figure 13 — Example of test set-up for tests applied to shielded lines (according to 7.5) and to apply potential differences (according to 7.6), conductive coupling	25		
Figure 14 — Example of test set-up for tests applied to unshielded lines and shielded lines earthed only at one end (according to 7.5) and to apply potential differences (according to 7.6), conductive coupling	25		
Figure B.1 — Example for surge protection by shielding in buildings with common earth reference system	29		
Figure B.2 — Example for secondary surge protection in buildings with separate common earth reference systems	29		

www.Lisungroup.com



## Introduction

This standard is part of the IEC 1000 series, according to the following structure:

### Part 1: General

General considerations (introduction, fundamental principles)

Definitions, terminology

### Part 2: Environment

Description of the environment

Classification of the environment

Compatibility levels

### Part 3: Limits

Emission limits

Immunity limits (in so far as they do not fall under the responsibility of the product committees)

### Part 4: Testing and measurement techniques

Measurement techniques

Testing techniques

### Part 5: Installation and mitigation guidelines

Installation guidelines

Mitigation methods and devices

### Part 9: Miscellaneous

Each part is further subdivided into sections which are to be published either as International Standards or as technical reports.

This section is an International Standard which gives immunity requirements and test procedures related to surge voltages and surge currents.

## 1 Scope and object

This section of IEC 1000-4 relates to the immunity requirements, test methods, and range of recommended test levels for equipment to unidirectional surges caused by overvoltages from switching and lightning transients. Several test levels are defined which relate to different environment and installation conditions. These requirements are developed for and are applicable to electrical and electronic equipment.

The object of this section is to establish a common reference for evaluating the performance of equipment when subjected to high-energy disturbances on the power and interconnection lines.

This standard defines:

- range of test levels;
- test equipment;
- test set-up;
- test procedure.

The task of the described laboratory test is to find the reaction of the EUT under specified operational conditions caused by surge voltages from switching and lightning effects at certain threat levels.

It is not intended to test the capability of the insulation to withstand high-voltage stress. Direct lightning is not considered in this standard.

This standard does not intend to specify the tests to be applied to particular apparatus or systems. Its main aim is to give a general basic reference to all concerned product committees of the IEC. The product committees (or users and manufacturers of equipment) remain responsible for the appropriate choice of the tests and the severity level to be applied to their equipment.

## 2 Normative references

The following normative documents contain provisions which, through reference in this text, constitute provisions of this section of IEC 1000-4. At the time of publication, the editions indicated were valid. All normative documents are subject to revision, and parties to agreements based on this section of IEC 1000-4 are encouraged to investigate the possibility of applying the most recent editions of the normative documents indicated below. Members of IEC and ISO maintain registers of currently valid International Standards.

IEC 50(161):1990, *International Electrotechnical Vocabulary (IEV) — Chapter 161: Electromagnetic compatibility*.

IEC 60-1:1989, *High-voltage test techniques — Part 1: General definitions and test requirements*.

IEC 469-1:1987, *Pulse techniques and apparatus — Part 1: Pulse terms and definitions*.

## 3 General

### 3.1 Switching transients

System switching transients can be separated into transients associated with:

- a) major power system switching disturbances, such as capacitor bank switching;
- b) minor switching activity near the instrumentation or load changes in the power distribution system;
- c) resonating circuits associated with switching devices, such as thyristors;
- d) various system faults, such as short-circuits and arcing faults to the earthing system of the installation.

### 3.2 Lightning transients

The major mechanisms by which lightning produces surge voltages are the following:

- a) a direct lightning strike to an external circuit (outdoor) injecting high currents producing voltages by either flowing through earth resistance or flowing through the impedance of the external circuit;
- b) an indirect lightning strike (i.e. a strike between or within clouds or to nearby objects which produces electromagnetic fields) that induces voltages/currents on the conductors outside and/or inside a building;
- c) lightning earth current flow resulting from nearby direct-to-earth discharges coupling into the common earth paths of the earthing system of the installation.

The rapid change of voltage and flow of current which may occur when a protector is excited may couple into internal circuits.

### 3.3 Simulation of the transients

- a) The characteristics of the test generator are such that it simulates the above-mentioned phenomena as closely as possible;
- b) if the source of interference is in the same circuit, e.g. in the power supply network (direct coupling), the generator may simulate a low impedance source at the ports of the equipment under test;
- c) if the source of interference is not in the same circuit (indirect coupling) as the ports of the victim-equipment, then the generator may simulate a higher impedance source.

## 4 Definitions

For the purposes of this section of IEC 1000-4, the following definitions together with those in IEC 50(161) apply, unless otherwise stated.

### 4.1

#### balanced lines

a pair of symmetrically driven conductors with a conversion loss from differential to common mode of less than 20 dB

### 4.2

#### coupling network

electrical circuit for the purpose of transferring energy from one circuit to another

#### 4.3

##### **decoupling network**

electrical circuit for the purpose of preventing surges applied to the EUT from affecting other devices, equipment or systems which are not under test

#### 4.4

##### **duration**

the absolute value of the interval during which a specified waveform or feature exists or continues [IEC 469-1]

#### 4.5

##### **EUT**

equipment under test

#### 4.6

##### **front time**

##### **surge voltage**

the front time  $T_1$  of a surge voltage is a virtual parameter defined as 1,67 times the interval  $T$  between the instants when the impulse is 30 % and 90 % of the peak value (see Figure 2)

##### **current surge**

the front time  $T_1$  of a surge current is a virtual parameter defined as 1,25 times the interval  $T$ , between the instants when the impulse is 10 % and 90 % of the peak value (see Figure 3) [IEC 60-1 modified]

#### 4.7

##### **immunity**

the ability of a device, equipment or system to perform without degradation in the presence of an electromagnetic disturbance [IEV 161-01-20]

#### 4.8

##### **electrical installation**

an assembly of associated electrical equipment to fulfil a specific purpose or purposes and having coordinated characteristics [IEV 826-01-01]

#### 4.9

##### **interconnection lines** consist of:

- I/O lines (input/output lines);
- communication lines;
- balanced lines

#### 4.10

##### **primary protection**

the means by which the majority of stressful energy is prevented from propagating beyond the designated interface

#### 4.11

##### **rise time**

the interval of time between the instants at which the instantaneous value of a pulse first reaches a specified lower value and then a specified upper value

NOTE Unless otherwise specified, the lower and upper values are fixed at 10 % and 90 % of the pulse magnitude. [IEV 161-02-05]

#### 4.12

##### **secondary protection**

the means by which the let-through energy from primary protection is suppressed. It may be a special device or an inherent characteristic of the EUT



**4.13****surge**

a transient wave of electrical current, voltage, or power propagating along a line or a circuit and characterized by a rapid increase followed by a slower decrease

[IEV 161-08-11 modified]

**4.14****system**

set of interdependent elements constituted to achieve a given objective by performing a specified function

**NOTE** The system is considered to be separated from the environment and other external systems by an imaginary surface which cuts the links between them and the considered system. Through these links, the system is affected by the environment, is acted upon by the external systems, or acts itself on the environment or the external systems.

[IEV 351-01-01]

**4.15****time to half-value  $T_2$** 

the time to half-value  $T_2$  of a surge is a virtual parameter defined as the time interval between the virtual origin  $O_1$  and the instant when the voltage current has decreased to half the peak value

[IEC 60-1 modified]

**4.16****transient**

pertaining to or designating a phenomenon or a quantity which varies between two consecutive steady states during a time interval short compared to the time-scale of interest

[IEV 161-02-01]

**5 Test levels**

The preferential range of test levels is given in Table 1.

**Table 1 — Test levels**

Level	Open-circuit test voltage $\pm 10\%$ kV
1	0,5
2	1,0
3	2,0
4	4,0
x	Special

**NOTE** x is an open class. This level can be specified in the product specification.

The test levels shall be selected according to the installation conditions; classes of installation are given in B.3 of Annex B.

All voltages of the lower test levels shall be satisfied (see 8.2).

For selection of the test levels for the different interfaces, see Annex A.

## 6 Test instrumentation

### 6.1 Combination wave (hybrid) generator (1,2/50 $\mu$ s – 8/20 $\mu$ s)

A simplified circuit diagram of the generator is given in Figure 1. The values for the different components  $R_{s1}$ ,  $R_{s2}$ ,  $R_m$ ,  $L_r$ , and  $C_c$  are selected so that the generator delivers a 1,2/50  $\mu$ s voltage surge (at open-circuit conditions) and a 8/20  $\mu$ s current surge into a short-circuit, i.e. the generator has an effective output impedance of 2  $\Omega$ .

For convenience, an effective output impedance is defined for a surge generator by calculating the ratio of peak open-circuit output voltage and peak short-circuit current.

Such a generator with 1,2/50  $\mu$ s open-circuit voltage waveform 8/20  $\mu$ s short-circuit current waveform is referred to as a combination wave generator (CWG) or hybrid generator.

NOTE 1 The waveform of the voltage and current is a function of the EUT input impedance. This impedance may change during surges to equipment and due either to proper operation of the installed protection devices, or to flashover or component breakdown, if the protection devices are absent or inoperative. Therefore the 1,2/50  $\mu$ s voltage and the 8/20  $\mu$ s current waves have to be available from the same test generator output as instantaneously required by the load.

NOTE 2 The combination wave generator described in this standard is identical to the hybrid generator sometimes specified in some other standards.

#### 6.1.1 Characteristics and performance of the combination wave generator

Open-circuit output voltage:

At least as low as	0,5 kV to at least as high as 4,0 kV
Waveform of the surge voltage	see Figure 2 and Table 2
Tolerance of the open circuit output voltage	$\pm 10\%$

Short-circuit output current:

At least as low as	0,25 kA to at least as high as 2,0 kA
Waveform of the surge current	see Figure 3 and Table 2
Tolerance of the short-circuit output current	$\pm 10\%$

Polarity

positive/negative

Phase shifting

in a range between 0° to 360° versus the a.c. line phase angle

Repetition rate

at least 1 per min

A generator with floating output shall be used.

Additional resistors (10  $\Omega$  or 40  $\Omega$ ) shall be included to increase the required effective source impedances for the specified test conditions (see clause 7 and B.1 of Annex B).

Under these circumstances, the open-circuit voltage waveform and the short-circuit current waveform in combination with the coupling/decoupling network are no longer 1,2/50  $\mu$ s and 8/20  $\mu$ s respectively (combination wave).

#### 6.1.2 Verification of the characteristics of the generator

In order to compare the test results from different test generators, the test generator characteristic shall be verified. For this purpose, the following procedure is necessary to measure the most essential characteristics of the generator.

The test generator output shall be connected to a measuring system with a sufficient bandwidth and voltage capability to monitor the characteristics of the waveforms.

The characteristics of the generator shall be measured under *open-circuit* conditions (load greater or equal to 10 k $\Omega$ ) and under *short-circuit* conditions (load smaller or equal to 0,1  $\Omega$ ) at the same charge voltage.

NOTE Short-circuit current: 0,25 kA minimum with the open-circuit voltage set to 0,5 kV and 2,0 kA minimum with the open-circuit voltage set to 4,0 kV.

### 6.2 Test generator 10/700 $\mu$ s according to CCITT

The simplified circuit diagram of the generator is given in Figure 4. The values for the different components  $R_c$ ,  $C_c$ ,  $R_{s1}$ ,  $R_{m1}$ ,  $C_s$  and  $R_{m2}$  are defined so that the generator delivers a 10/700  $\mu$ s surge.

### 6.2.1 Characteristics and performances of the generator

Open-circuit output voltage:	
At least as low as	0,5 kV to at least as high as 4,0 kV
Waveform of the surge voltage	see Figure 5 (IEC 60-1) and Table 3
Tolerance of the open-circuit output voltage	±10 %
Short-circuit output current:	
At least as low as	12,5 A to at least as high as 100 A
Waveform of the surge current	see Table 3
Tolerance of the short-circuit output current	±10 %
Polarity	positive/negative
Repetition rate	at least 1 per min

A generator with floating output shall be used.

### 6.2.2 Verification of the characteristics of the generator

The verification conditions for the 10/700  $\mu$ s test generator are identical to 6.1.2 with the following note.

NOTE Short-circuit current: 12,5 A minimum with the open-circuit voltage set to 0,5 kV, and 100 A minimum with the open-circuit voltage set to 4,0 kV.

### 6.3 Coupling/decoupling networks

The coupling/decoupling networks shall not significantly influence the parameters of the generators e.g. open-circuit voltage, short-circuit current capability as in the specified tolerances.

*Exception:* Coupling via arrester.

NOTE Lossy material for the inductances reduces ringing.

Each coupling/decoupling network shall satisfy the following requirements:

#### 6.3.1 Coupling/decoupling networks for a.c./d.c. power supply circuits (only used with combination wave generator)

The front time and surge time to half value shall be verified for voltage under open-circuit conditions and for current under short-circuit conditions.

The test generator output or its coupling network shall be connected to a measuring system with a sufficient bandwidth and voltage capability to monitor the open-circuit voltage waveform.

The short-circuit current waveform can be measured with a current transformer through whose aperture passes a short-circuit link between the output terminals of the coupling network.

All waveform definitions, as well as all other performance parameters of the test generator, should be as specified in 6.1.1 at the output of the coupling/decoupling network as well as at the output of the generator itself.

NOTE When the generator impedance is increased from 2  $\Omega$  to e.g. 12  $\Omega$  or 42  $\Omega$  according to the requirements of the test set-up, the duration of the test pulse at the output of the coupling network might be significantly changed.

##### 6.3.1.1 Capacitive coupling for power supply circuits

Capacitive coupling enables the test voltage to be applied line to line or one line to earth while the power supply decoupling network is also connected. The circuit diagrams for single phase systems are shown in Figure 6 and Figure 7 and for three-phase systems are shown in Figure 8 and Figure 9.

Rated characteristics of the coupling/decoupling network:

*Coupling:*

coupling capacitors:  $C = 9 \mu\text{F}$  or  $18 \mu\text{F}$  (see test set-up)

*Decoupling:*

decoupling inductance for supply voltage:  $L = 1,5 \text{ mH}$

The residual surge voltage on unsurged lines shall not exceed 15 % of the maximum applicable test voltage when the EUT is disconnected.



The residual surge voltage on the power supply inputs of the decoupling network when the EUT and the power supply network are disconnected, shall not exceed 15 % of the applied test voltage or twice peak value of the power line voltage whichever is higher.

The above mentioned characteristics for single-phase systems (line, neutral, protective earth) are also valid for three-phase systems (three-phase wires, neutral and protective earth).

#### 6.3.1.2 Inductive coupling for power supply

Under consideration.

#### 6.3.2 Coupling/decoupling networks for interconnection lines

The coupling method shall be selected as a function of the circuits and operational conditions. This has to be specified in the product specification.

Examples of coupling methods are the following:

- capacitive coupling;
- coupling via arrestors.

The different set-ups defined in the following subclauses to test a given port of the EUT may not give comparable results. The most suitable set-up has to be selected in the product specification/standard.

NOTE  $R_L$  in Figure 10 to Figure 12 represents the resistive part of the inductance  $L$  and the value is dependent on negligible attenuation of the transmission signal.

##### 6.3.2.1 Capacitive coupling for interconnection lines

The capacitive coupling is the preferred method for unbalanced unshielded I/O circuits when there is no influence to the functional communication on that line. The application is in accordance with Figure 10 for line-to-line coupling and for line-to-earth coupling.

Rated characteristics of the capacitive coupling/decoupling network:

Coupling capacitor  $C$ : 0,5  $\mu\text{F}$

Decoupling inductors  $L$  (not current compensated): 20 mH

NOTE Signal current capability has to be considered and is dependent on the circuits under test.

##### 6.3.2.2 Coupling via arrestors

Coupling via arrestors is the preferred coupling method for unshielded balanced circuits (telecommunication), as shown in Figure 12.

The method can also be used in cases where the capacitive coupling is not possible because of functional problems caused by attachment of capacitors to the EUT (see Figure 11).

The coupling network also has the task to accommodate the distribution of the surge current in the case of induced voltages in multiconductor cables.

Therefore the resistances  $R_{m2}$  in the coupling network shall be, for  $n$  composite conductors,  $n \times 25 \Omega$  (for  $n$  equal to or greater than 2).

EXAMPLE:  $n = 4$ ,  $R_{m2} = 4 \times 25 \Omega$ . With the impedance of the generator the total value is approximately 40  $\Omega$ .  $R_{m2}$  shall not exceed 250  $\Omega$ .

The coupling via gas-filled arrestors can be improved by capacitors in parallel with the arrestors.

EXAMPLE:  $C \leq 0,1 \mu\text{F}$  for frequencies of the transmission signal on the line below 5 kHz. At higher frequencies no capacitors are used.

Rated characteristics of the coupling/decoupling network:

- coupling resistance  $R_{m2}$   $n \times 25 \Omega$  (for  $n$  equal to or greater than 2)
- arrestor (gas-filled) 90 V
- decoupling inductor  $L$  20 mH  
(ring core, current compensated)

NOTE 1 In some cases, arrestors with higher activation voltages are used for functional reasons.

NOTE 2 Other elements than arrestors may be used when the operational conditions are not unduly influenced.

##### 6.3.3 Other coupling methods

Other coupling methods are under consideration.

## 7 Test set-up

### 7.1 Test equipment

The following equipment is part of the test set-up:

- equipment under test (EUT);
- auxiliary equipment (AE);
- cables (of specified type and length);
- coupling device (capacitive or arrestors);
- test generator (combination wave generator, 10/700  $\mu$ s generator);
- decoupling network/protection devices;
- additional resistors, 10  $\Omega$  and 40  $\Omega$  (see B.1 of Annex B).

### 7.2 Test set-up for tests applied to EUT power supply

The surge is to be applied to the EUT power supply terminals via the capacitive coupling network (see Figure 6, Figure 7, Figure 8 and Figure 9). Decoupling networks are required in order to avoid possible adverse effects on equipment not under test that may be powered by the same lines and to provide sufficient decoupling impedance to the surge wave so that the specified wave may be developed on the lines under test.

If not otherwise specified the power cord between the EUT and the coupling/decoupling network shall be 2 m in length (or shorter).

To simulate the representative coupling impedances, in some cases additional specified resistors have to be used for the tests (explanations, see B.1 of Annex B).

NOTE In some countries (e.g. USA) standards for a.c. lines require the tests according to Figure 7 and Figure 9 with a 2  $\Omega$  impedance although this is a more severe test. The general requirement is 10  $\Omega$ .

### 7.3 Test set-up for tests applied to unshielded unsymmetrically operated interconnection lines

In general, the surge is applied to the lines in accordance with Figure 10 via capacitive coupling. The coupling/decoupling network shall not influence the specified functional conditions of the circuits to be tested.

An alternative test set-up (coupling via arrestors) is given in Figure 11 for circuits with a higher signal transfer rate. Selection shall be made depending on the capacitive load with respect to the transmission frequency.

If not otherwise specified, the interconnection line between the EUT and the coupling/decoupling network shall be 2 m in length (or shorter).

### 7.4 Test set-up for tests applied to unshielded symmetrically operated interconnection/telecommunication lines (Figure 12)

For balanced interconnection/telecommunication circuits, the capacitive coupling method can normally not be used. In this case, the coupling is performed via gas arrestors (CCITT Recommendation K.17). Test levels below the ignition point of the coupling arrestor (about 300 V for a 90 V arrestor) cannot be specified (except in the case of secondary protection without gas arrestors).

NOTE Two test configurations are to be considered:

- for the equipment level immunity test with only secondary protection at the EUT at a low test level, e.g. 0,5 kV or 1 kV.
- for the system level immunity test with additional primary protection at a higher test level, e.g. 2 kV or 4 kV.

If not otherwise specified the interconnection line between the EUT and the coupling/decoupling network shall be 2 m in length (or shorter).

### 7.5 Test set-up for tests applied to shielded lines

In the case of shielded lines a coupling/decoupling network may not be applicable.

Thus the surge is applied to the shields (metallic enclosures) of the EUTs and connected shields of the lines in accordance with Figure 13. For shields connected at one end Figure 14 applies. For decoupling the connected safety earthwire a safety isolating transformer shall be used. Normally, the maximum length of the specified shielded cable shall be used. With respect to the frequency spectrum of the surge 20 m length of the specified shielded cable shall be used in non-inductively bundled configuration for physical reasons.

Rules for application of the surge to shielded lines:

a) *Shields earthed at both ends*

— the surge injection on the shield shall be carried out according to Figure 13.

b) *Shields earthed at one end*

— the test shall be carried out according to Figure 14. The capacitor  $C$  represents the cable capacity to earth and the value may be calculated with 100 pF/m. As a representative value 10 nF may be used unless otherwise specified.

The test level applied on shields is the "line-to-earth value" ( $2 \Omega$  impedance).

### 7.6 Test set-up to apply potential differences

If it is necessary to apply potential differences which simulate voltages that can occur within a system, the tests may be carried out in accordance with Figure 13 for systems with shielded lines, shields earthed at both ends, and in accordance with Figure 14 for systems with unshielded lines or shielded lines earthed only at one end.

### 7.7 Other test set-ups

If one of the specified coupling methods in the test set-up cannot be used for functional reasons, alternative methods (suitable for the special case) shall be specified in the dedicated product standard.

### 7.8 Test conditions

The operational test conditions and the installation conditions shall be in accordance with the product specification and shall include the:

- test configuration (hardware);
- test procedure (software).

## 8 Test procedure

### 8.1 Laboratory reference conditions

In order to minimize the impact of environmental parameters on test results, the test shall be carried out in climatic and electromagnetic reference conditions as specified in 8.1.1 and 8.1.2.

#### 8.1.1 Climatic conditions

**(A)** Unless otherwise specified by the committee responsible for the generic or product standard, the climatic conditions in the laboratory shall be within any limits specified for the operation of the EUT and the test equipment by their respective manufacturers.

Tests shall not be performed if the relative humidity is so high as to cause condensation on the EUT or the test equipment.

**NOTE** Where it is considered that there is sufficient evidence to demonstrate that the effects of the phenomenon covered by this standard are influenced by climatic conditions, this should be brought to the attention of the committee responsible for this standard. **(A)**

#### 8.1.2 Electromagnetic conditions

The electromagnetic environment of the laboratory shall not influence the test results.



## 8.2 Application of the surge in the laboratory

The characteristics and performance of the test generators shall be as specified in 6.1.1 and 6.2.1; the calibration of the generators shall be performed according to 6.1.2 and 6.2.2.

The test shall be performed according to the test plan that shall specify (see also B.2 of Annex B) the test set-up with:

- generator and other equipment utilized;
- test level (voltage/current) (see Annex A);
- generator source impedance;
- polarity of the surge;
- internal or external generator trigger;
- number of tests: at least five positive and five negative at the selected points;
- repetition rate: maximum 1/min.

**NOTE** Most protectors in common use have low average power capabilities, even though their peak power or peak energy handling can deal with high currents. Therefore the maximum repetition rate (the time between two surges and the recovery time) depends on the built-in protection devices of the EUT.

- inputs and outputs to be tested;

**NOTE** In the case of several identical circuits representative measurements on a selected number of circuits may be sufficient.

- representative operating conditions of the EUT;
- sequence of application of the surge to the circuits;
- phase angle in the case of a.c. power supply;
- actual installation conditions, for example:

AC: neutral earthed,

DC: (+) or (-) earthed to simulate the actual earthing conditions.

Information on the mode to perform the tests is given in B.2 of Annex B.

If not otherwise specified the surges have to be applied synchronized to the voltage phase at the zero-crossing and the peak value of the a.c. voltage wave (positive and negative).

The surges have to be applied line to line and line(s) and earth. When testing line to earth the test voltage has to be applied successively between each of the lines and earth, if there is no other specification.

**NOTE** When using the combination wave generator to test two or more lines (telecommunication lines) to earth the duration of the test pulse might be reduced.

The test procedure shall also consider the non-linear current-voltage characteristics of the equipment under test. Therefore the test voltage has to be increased by steps up to the test level specified in the product standard or test plan.

All lower levels including the selected test level shall be satisfied. For testing the secondary protection, the output voltage of the generator shall be increased up to the worst-case voltage breakdown level (let-through level) of the primary protection.

If the actual operating signal sources are not available, they may be simulated. Under no circumstances may the test level exceed the product specification. The test shall be carried out according to a test plan.

To find all critical points of the duty cycle of the equipment, a sufficient number of positive and negative test pulses shall be applied. For acceptance test a previously unstressed equipment shall be used or the protection devices shall be replaced.

## 9 Evaluation of test results

The test results shall be classified in terms of the loss of function or degradation of performance of the equipment under test, relative to a performance level defined by its manufacturer or the requestor of the test, or agreed between the manufacturer and the purchaser of the product. The recommended classification is as follows:

- a) normal performance within the limits specified by the manufacturer, requestor or purchaser;
- b) temporary loss of function or degradation of performance which ceases after the disturbance ceases, and from which the equipment under test recovers its normal performance, without operator intervention; (A<sub>1</sub>)



- A1)** c) temporary loss of function or degradation of performance, the correction of which requires operator intervention;
- d) loss of function or degradation of performance which is not recoverable, owing to damage to hardware of software, or loss of data.

The manufacturer's specification may define effects on the EUT which may be considered insignificant, and therefore acceptable.

This classification may be used as a guide in formulating performance criteria, by committees responsible for generic, product and product-family standards, or as a framework for the agreement on performance criteria between the manufacturer and the purchaser, for example where no suitable generic, product or product-family standard exists.

### 10 Test report

The test report shall contain all the information necessary to reproduce the test. In particular, the following shall be recorded:

- the items specified in the test plan required by clause 8 of this standard;
- identification of the EUT and any associated equipment, for example, brand name, product type, serial number;
- identification of the test equipment, for example, brand name, product type, serial number;
- any special environmental conditions in which the test was performed, for example, shielded enclosure;
- any specific conditions necessary to enable the test to be performed;
- performance level defined by the manufacturer, requestor or purchaser;
- performance criterion specified in the generic, product or product-family standard;
- any effects on the EUT observed during or after the application of the test disturbance, and the duration for which these effects persist;
- the rationale for the pass/fail decision (based on the performance criterion specified in the generic, product or product-family standard, or agreed between the manufacturer and the purchaser);
- any specific conditions of use, for example cable length or type, shielding or grounding, or EUT operating conditions, which are required to achieve compliance. **A1**

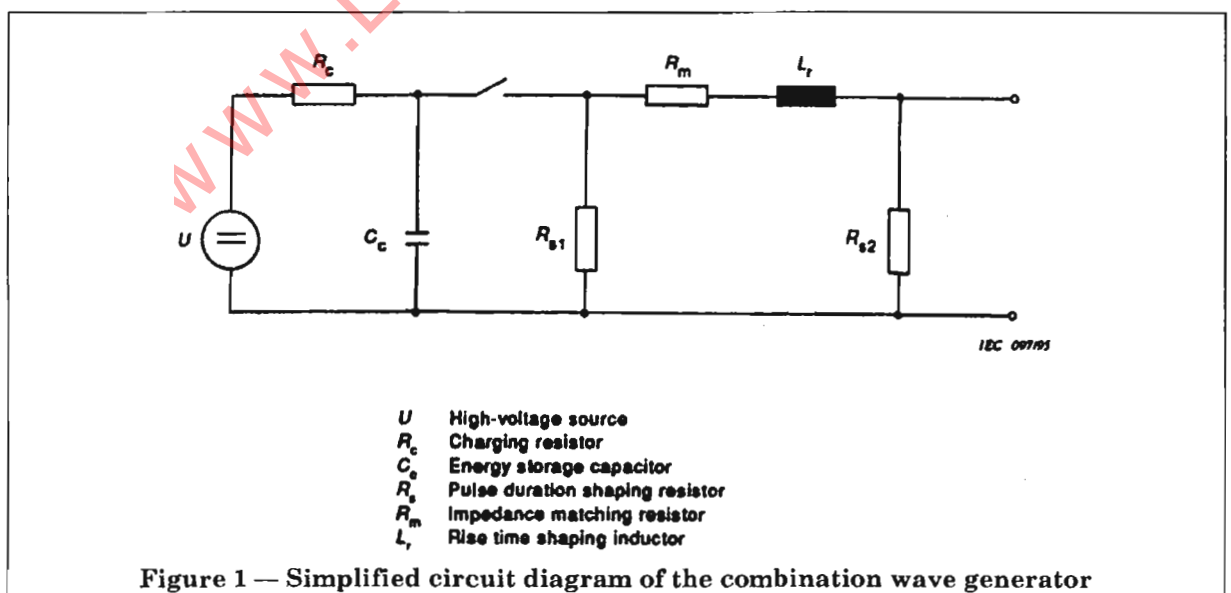
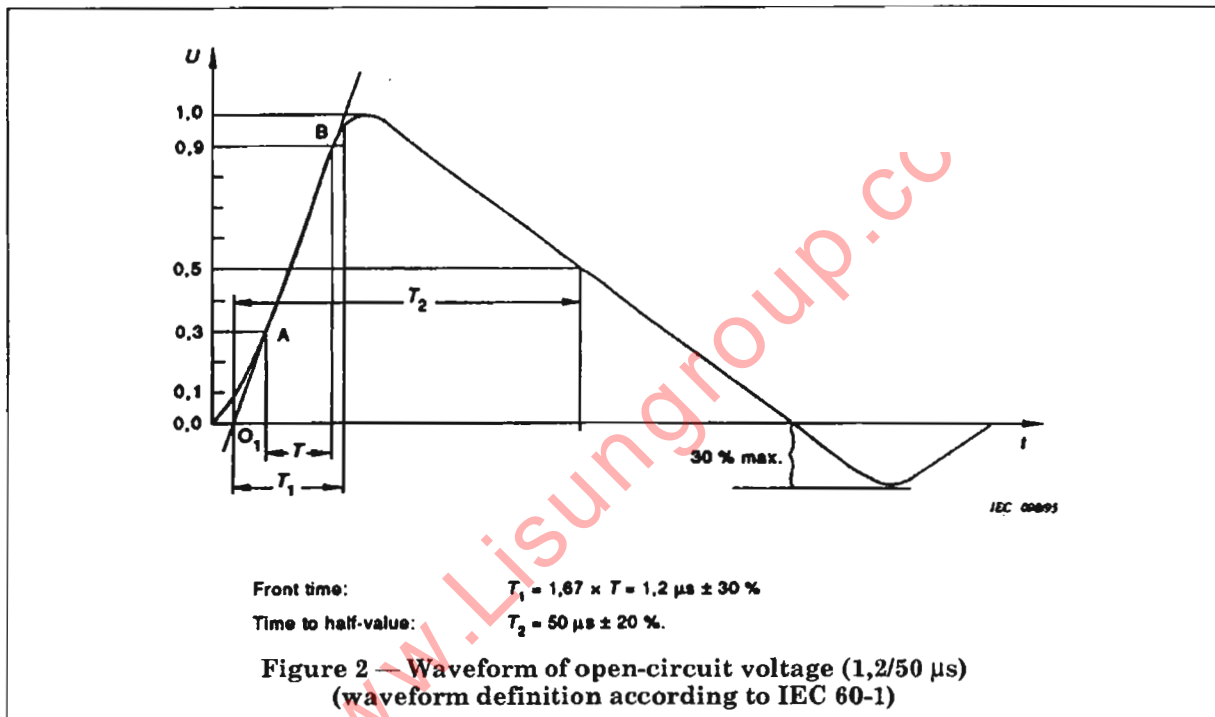

Table 2 — Definitions of the waveform parameters 1,2/50  $\mu$ s

Definitions	In accordance with IEC 60-1		In accordance with IEC 469-1	
	Front time $\mu$ s	Time to half value $\mu$ s	Rise time (10 % - 90 %) $\mu$ s	Duration time (50 % - 50 %) $\mu$ s
Open-circuit voltage	1,2	50	1	50
Short-circuit current	8	20	6,4	16

NOTE In existing IEC publications, the waveforms 1,2/50  $\mu$ s and 8/20  $\mu$ s are generally defined according to IEC 60-1 as shown in Figure 2 and Figure 3. Other IEC recommendations are based on waveform definitions according to IEC 469-1 as shown in Table 2.

Both definitions are valid for this section of IEC 1000-4 and describe just one single generator.



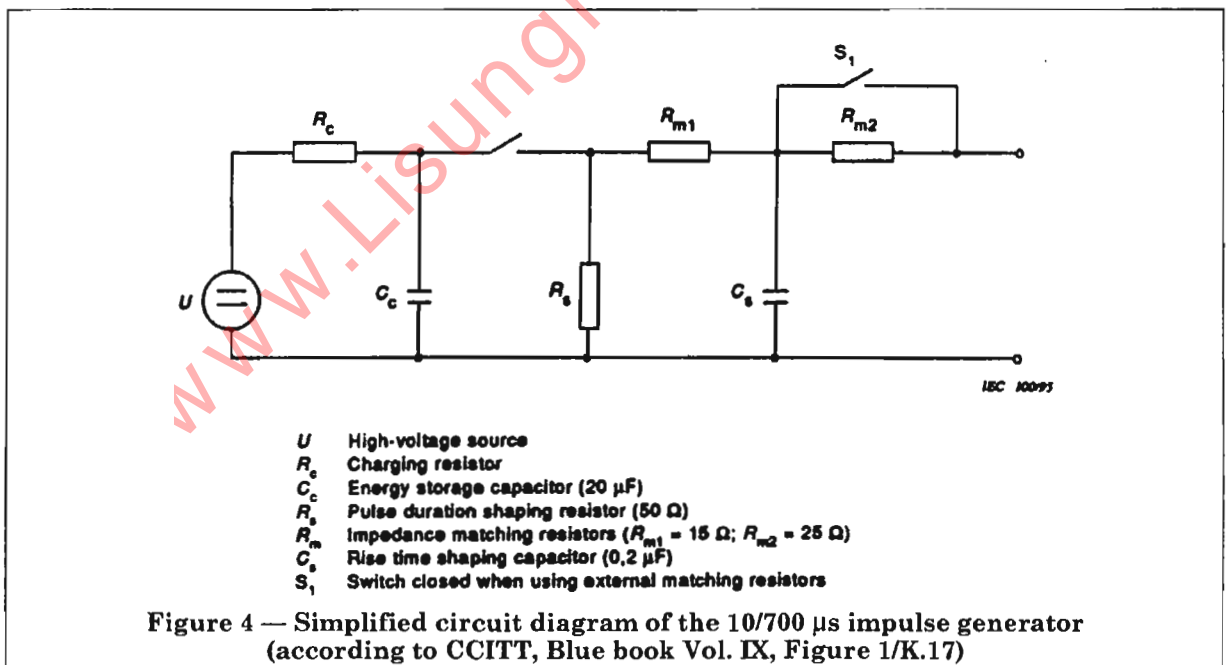
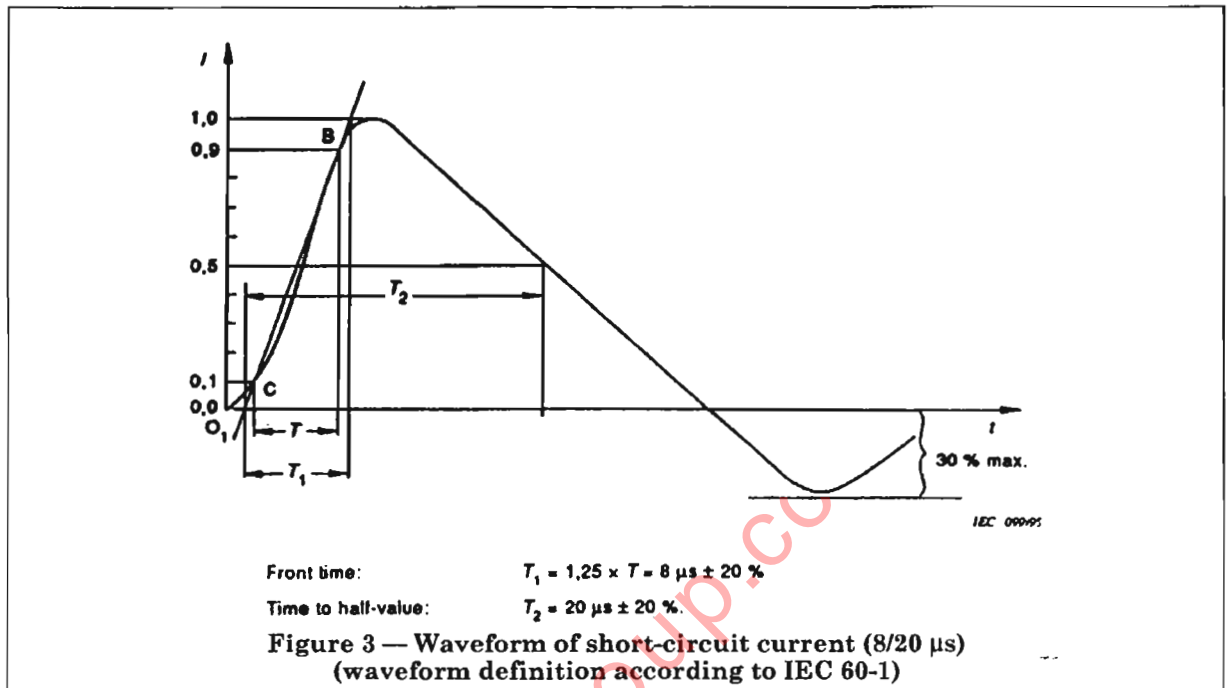
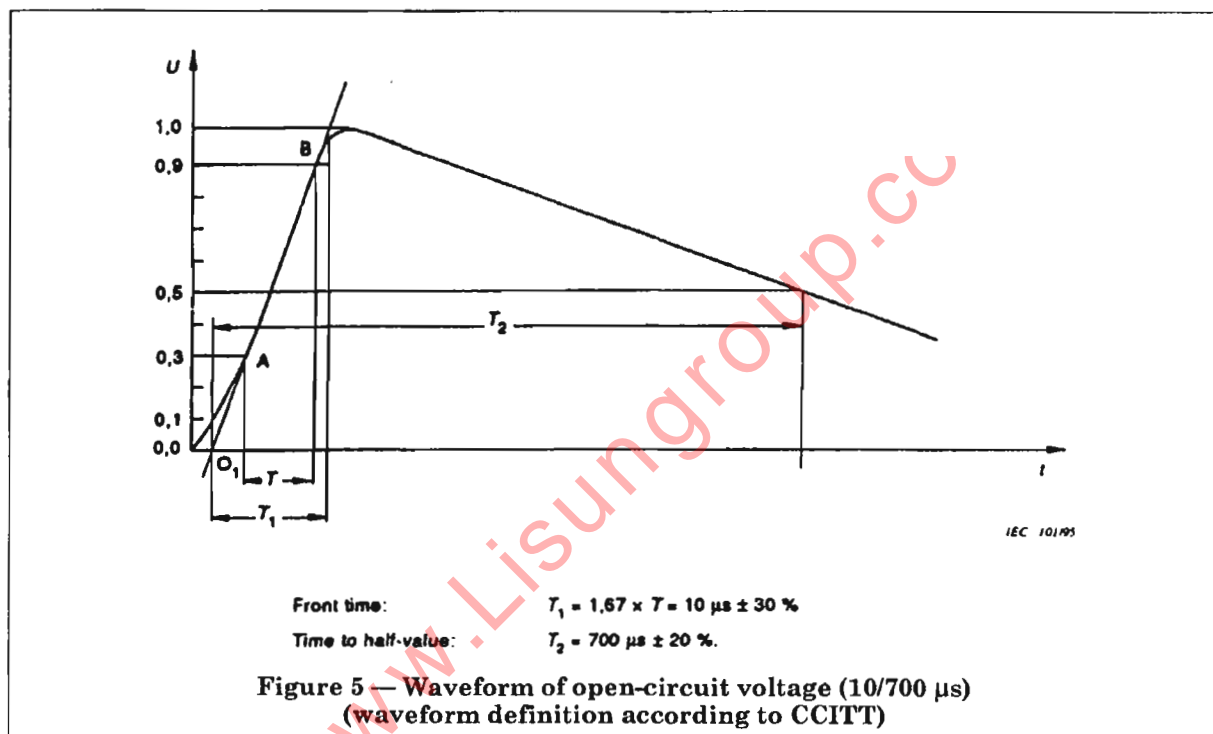

**Table 3 — Definitions of the waveform parameters 10/700  $\mu$ s**

Definitions	In accordance with CCITT, Blue book, Vol. IX		In accordance with IEC 469-1	
	Front time $\mu$ s	Time to half-value $\mu$ s	Rise time (10 % - 90 %) $\mu$ s	Duration time (50 % - 50 %) $\mu$ s
Open-circuit voltage	10	700	6,5	700
Short-circuit current	—	—	4	300

NOTE In existing IEC and CCITT publications, the waveform 10/700  $\mu$ s is generally defined according to IEC 60-1 as shown in Figure 5. Other IEC recommendations are based on waveform definitions according to IEC 469-1 as shown in Table 3.

Both definitions are valid for this section of IEC 1000-4 and describe just one single generator.



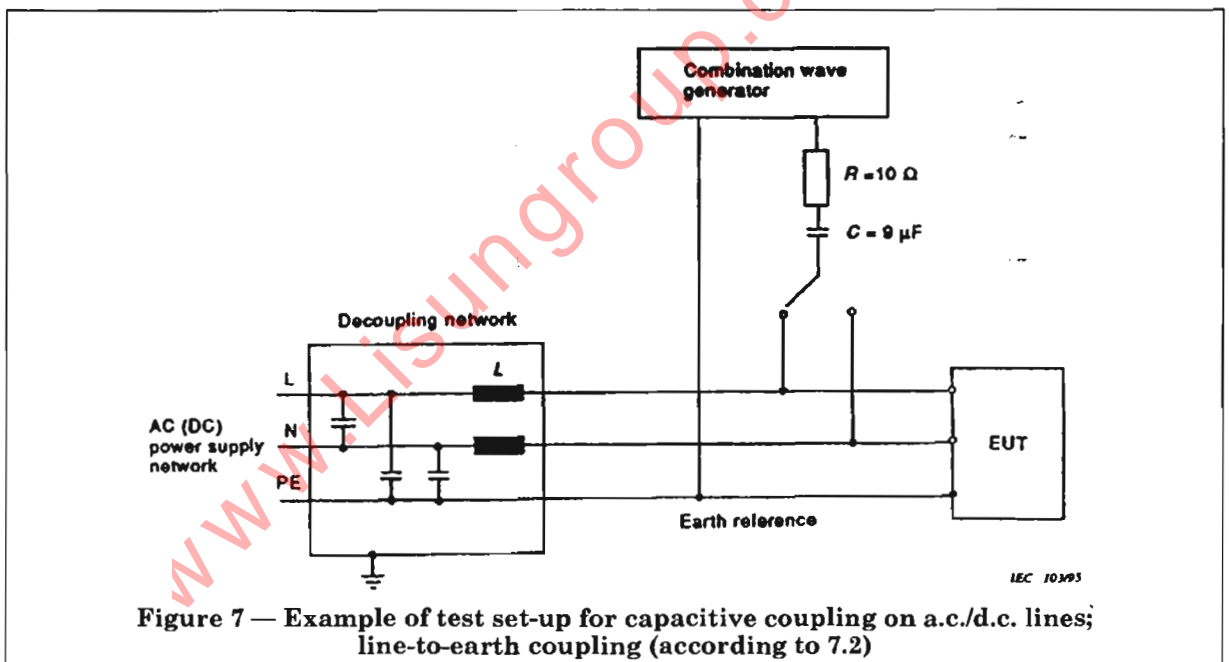
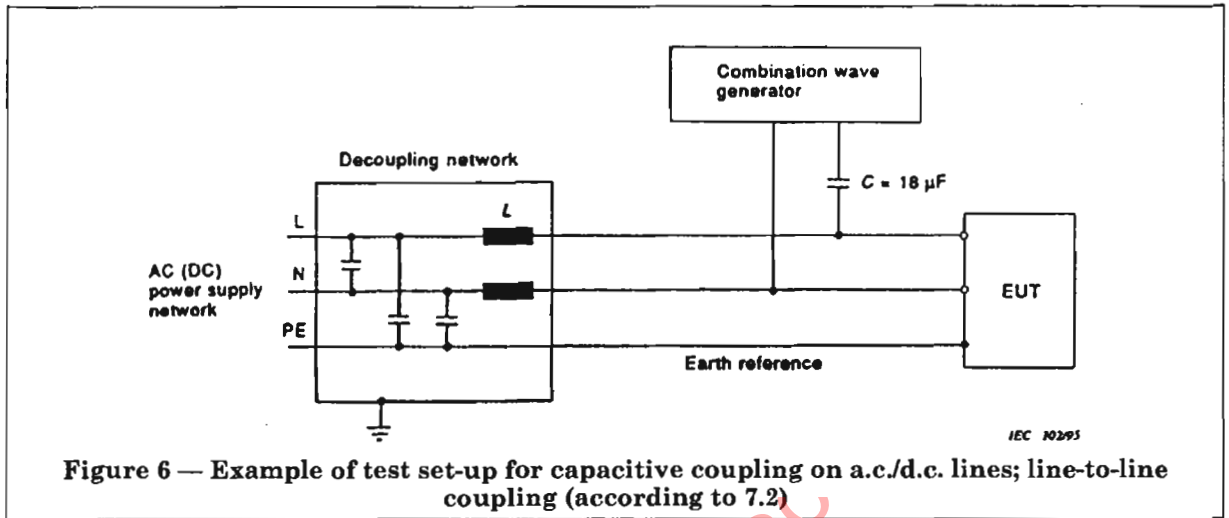

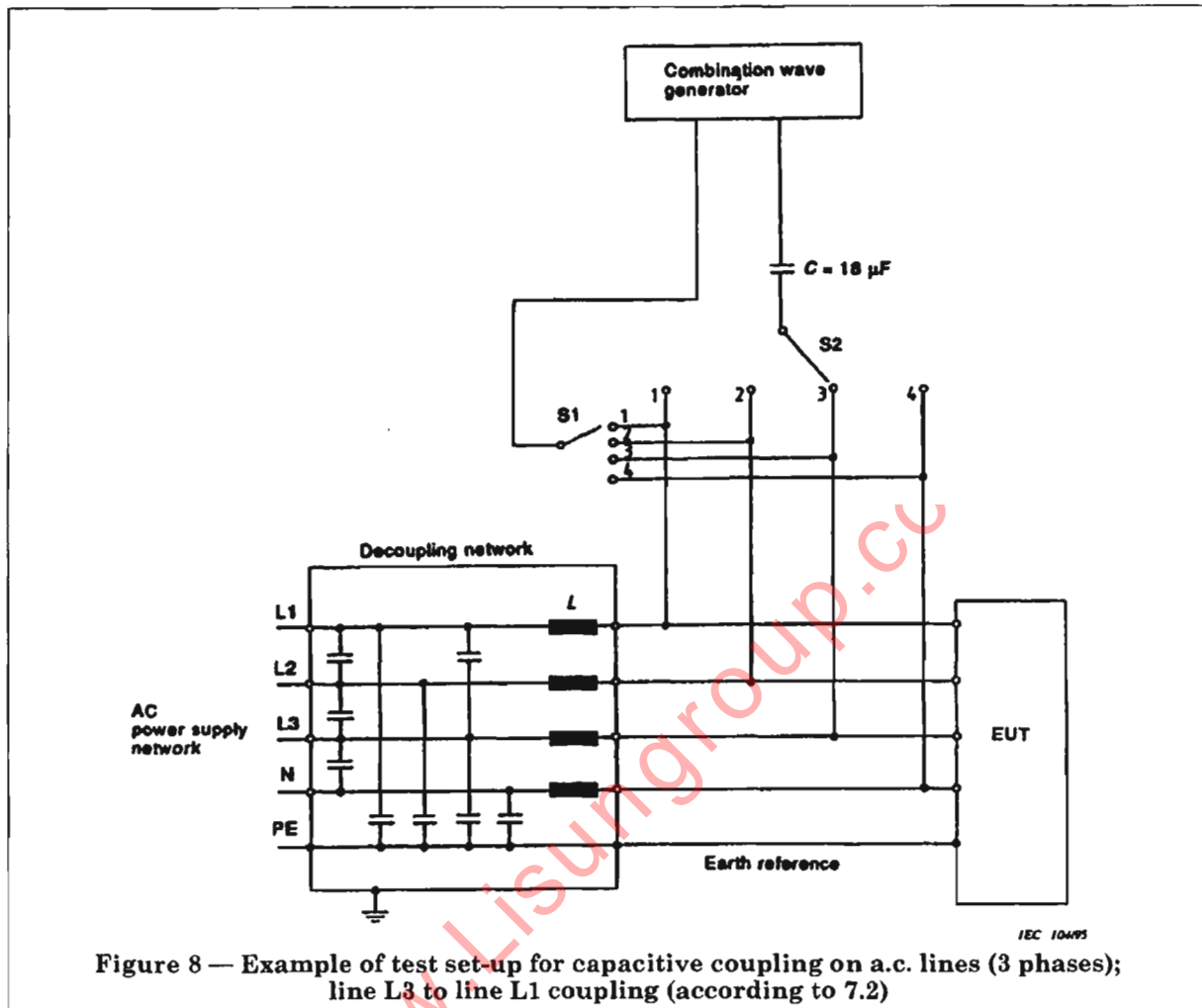
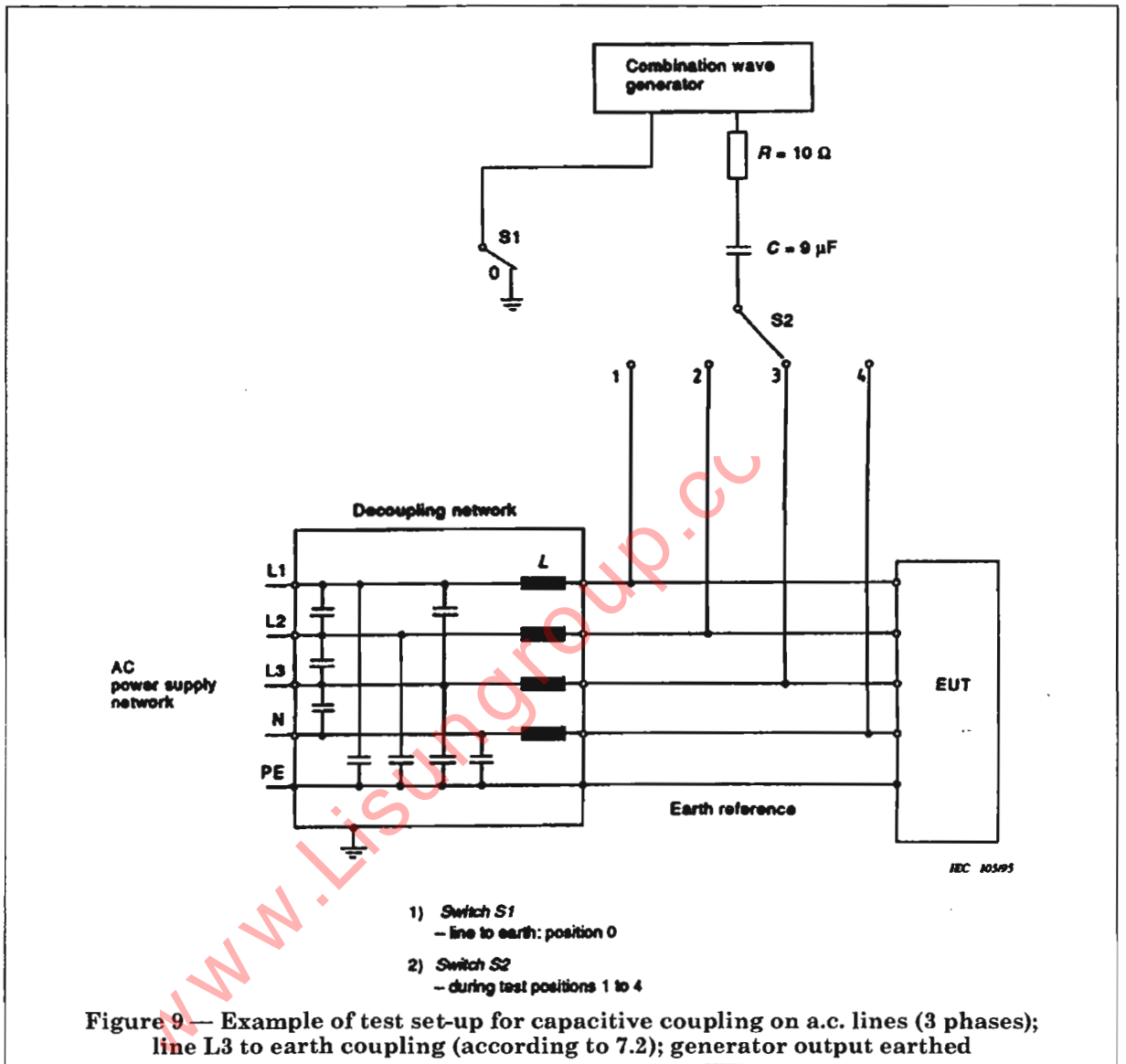
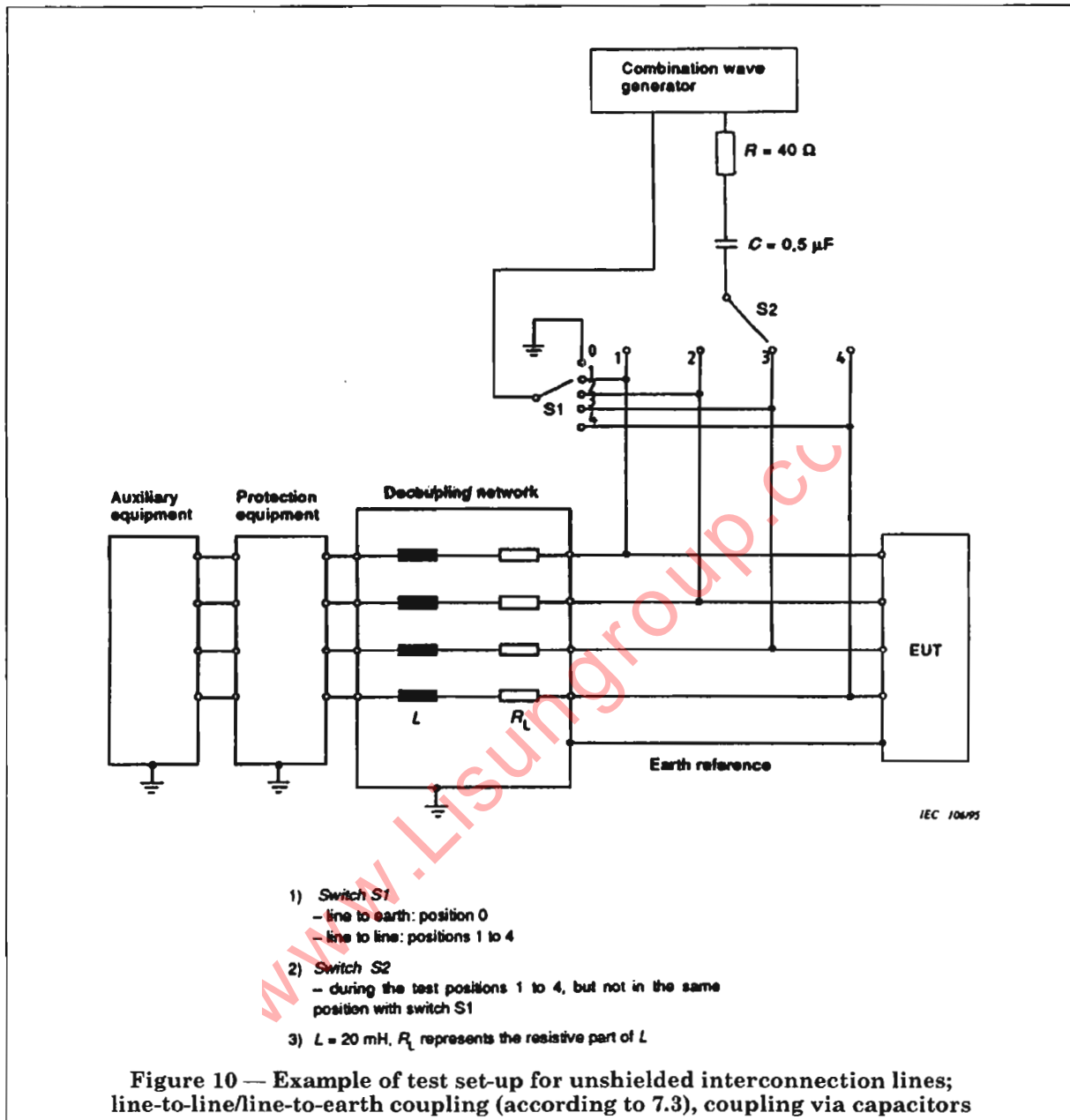

Figure 8 — Example of test set-up for capacitive coupling on a.c. lines (3 phases); line L3 to line L1 coupling (according to 7.2)







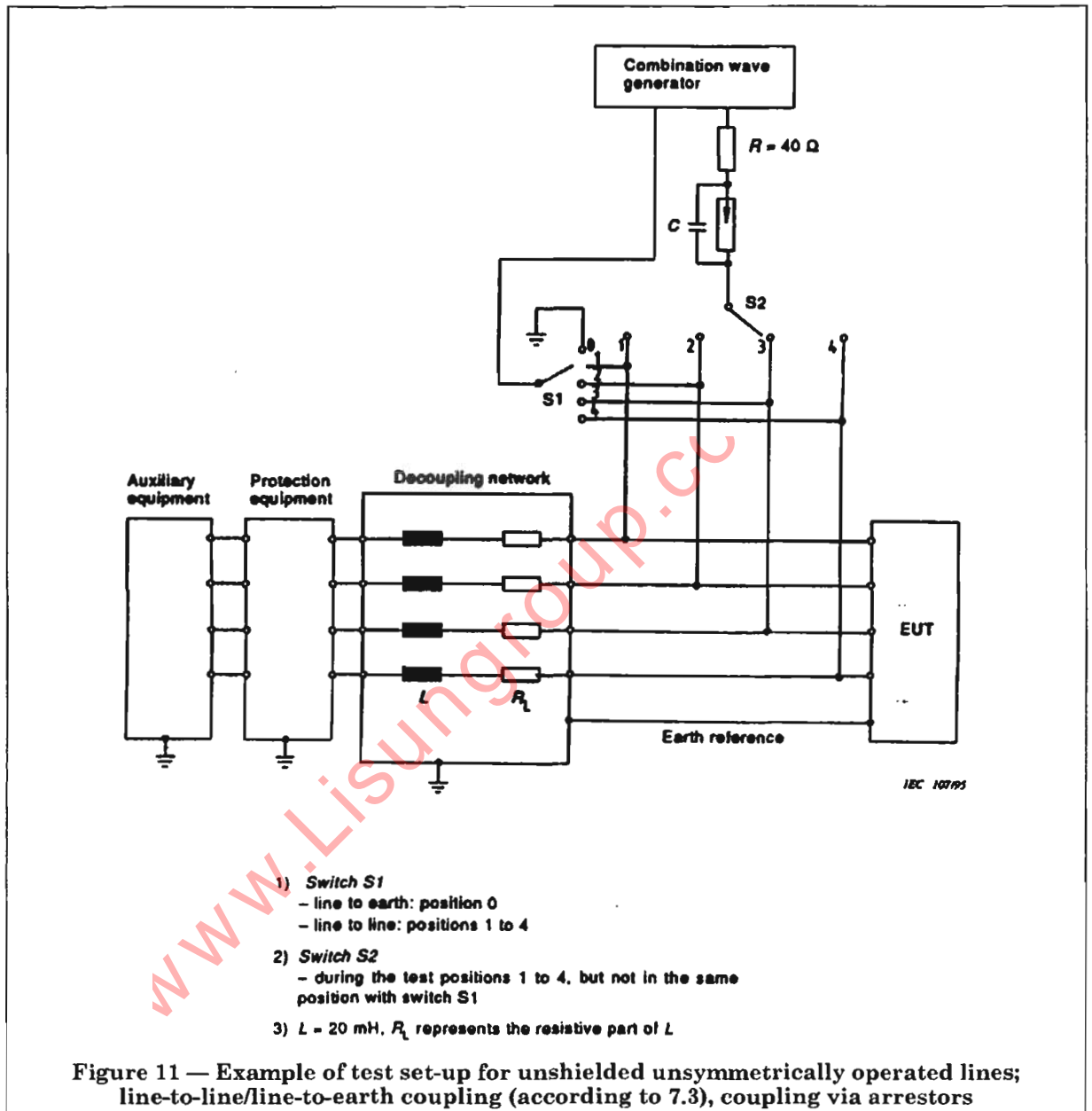
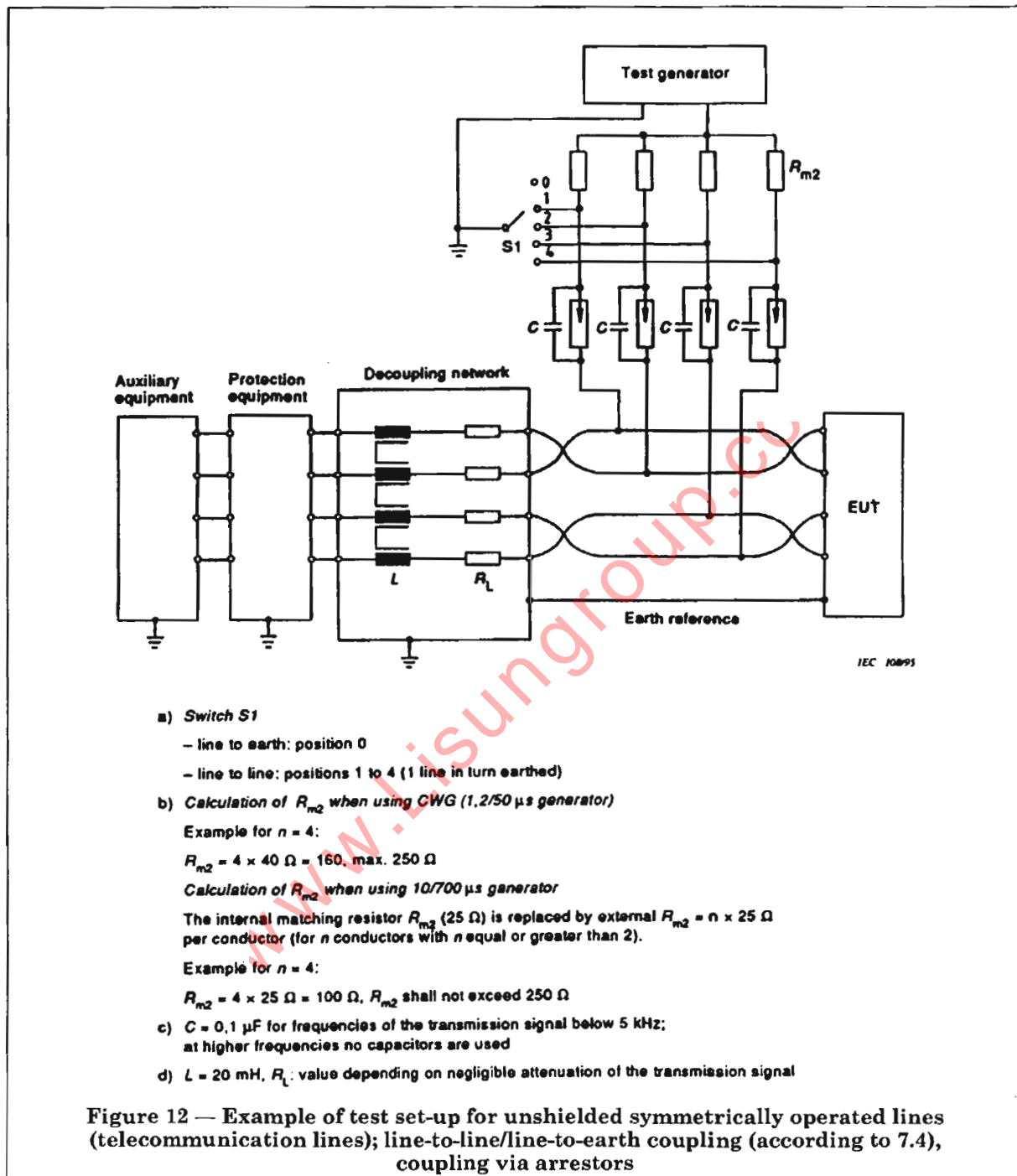

Figure 11 — Example of test set-up for unshielded unsymmetrically operated lines; line-to-line/line-to-earth coupling (according to 7.3), coupling via arrestors



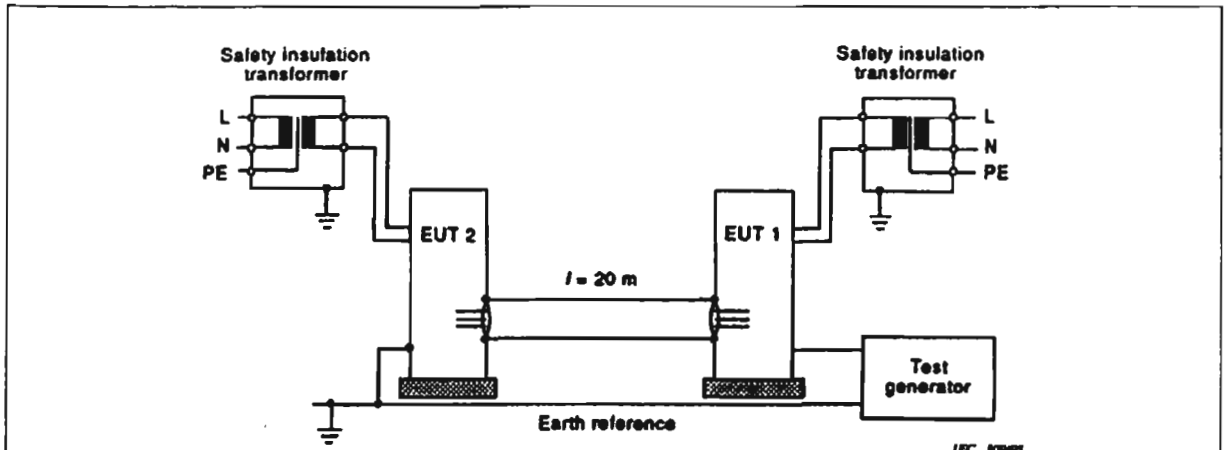

Figure 13 — Example of test set-up for tests applied to shielded lines (according to 7.5) and to apply potential differences (according to 7.6), conductive coupling

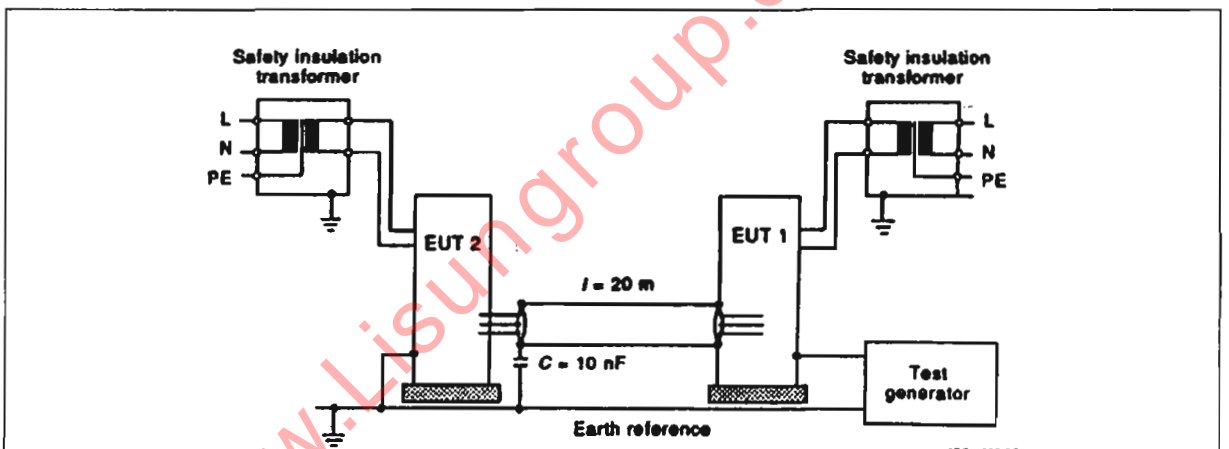

Figure 14 — Example of test set-up for tests applied to unshielded lines and shielded lines earthed only at one end (according to 7.5) and to apply potential differences (according to 7.6), conductive coupling

## Annex A (normative)

### Selection of generators and test levels

The selection of the test levels shall be based on the installation conditions. For this purpose Table A.1 should be used, together with information and examples given in B.3 of Annex B where:

- Class 0: Well-protected electrical environment, often within a special room.
- Class 1: Partly protected electrical environment.
- Class 2: Electrical environment where the cables are well separated, even at short runs.
- Class 3: Electrical environment where cables run in parallel.
- Class 4: Electrical environment where the interconnections are running as outdoor cables along with power cables, and cables are used for both electronic and electric circuits.
- Class 5: Electrical environment for electronic equipment connected to telecommunication cables and overhead power lines in a non-densely populated area.
- Class x: Special conditions specified in the product specification.

Additional information is given in Figure B.1 to Figure B.3 of Annex B.

To demonstrate the system level immunity, additional measures relevant to the actual installation conditions, e.g. primary protection, should be taken.

**Table A.1 — Selection of the test levels (depending on the installation conditions)**

Installation class	Test levels							
	Power supply		Unbalanced operated circuits/lines, LDB		Balanced operated circuits/lines		SDB, DB <sup>a</sup>	
	Coupling mode		Coupling mode		Coupling mode		Coupling mode	
	Line to line	Line to earth	Line to line	Line to earth	Line to line	Line to earth	Line to line	Line to earth
kV	kV	kV	kV	kV	kV	kV	kV	
0	NA	NA	NA	NA	NA	NA	NA	NA
1	NA	0,5	NA	0,5	NA	0,5	NA	NA
2	0,5	1,0	0,5	1,0	NA	1,0	NA	0,5
3	1,0	2,0	1,0	2,0 <sup>c</sup>	NA	2,0 <sup>c</sup>	NA	NA
4	2,0	4,0 <sup>c</sup>	2,0	4,0 <sup>c</sup>	NA	2,0 <sup>c</sup>	NA	NA
5	b	b	2,0	4,0 <sup>c</sup>	NA	4,0 <sup>c</sup>	NA	NA
x								

**Explanation:**

- DB = data bus (data line)
- SDB = short-distance bus
- LDB = long-distance bus
- NA = not applicable

<sup>a</sup> Limited distance, special configuration, special layout, 10 m to max. 30 m: no test is advised at interconnection cables up to 10 m, only class 2 is applicable.

<sup>b</sup> Depends on the class of the local power supply system.

<sup>c</sup> Normally tested with primary protection.

The surges (and test generators) related to the different classes are as in the following:

- Classes 1 to 4: 1,2/50  $\mu$ s (8/20  $\mu$ s).
- Class 5: 1,2/50  $\mu$ s (8/20  $\mu$ s) for ports of power lines and short-distance signal circuits/lines.  
10/700  $\mu$ s for ports of long-distance signal circuits/lines.

The source impedances shall be as indicated in the figures of the test set-ups concerned.

## **Annex B (informative)**

### **Explanatory notes**

#### **B.1 Different source impedances**

The selection of the source impedance of the generator depends on:

- the kind of cable/conductor/line (a.c. power supply, d.c. power supply, interconnection, etc.);
- the length of the cables/lines;
- indoor/outdoor conditions;
- application of the test voltage (line to line or lines to earth).

The impedance of  $2\ \Omega$  represents the source impedance of the low-voltage power supply network. The generator with its effective output impedance of  $2\ \Omega$  is used.

The impedance of  $12.7\ \Omega$  ( $10\ \Omega + 2\ \Omega$ ) represents the source impedance of the low-voltage power supply network and earth.

The generator with an additional resistor of  $10\ \Omega$  in series is used.

The impedance of  $42\ \Omega$  ( $40\ \Omega + 2\ \Omega$ ) represents the source impedance between all other lines and earth.

The generator with an additional resistor of  $40\ \Omega$  in series is used.

In some countries (for instance, USA) standards for a.c. lines require the tests according to Figure 7 and Figure 9 with a  $2\ \Omega$  impedance; this is a more severe test. The general requirement is  $10\ \Omega$ .

#### **B.2 Application of the tests**

Two different kinds of tests are to be distinguished: at equipment level and at system level.

##### **B.2.1 Equipment level immunity**

The test shall be carried out in the laboratory on a single EUT. The immunity of the EUT thus tested is referred to equipment level immunity.

The test voltage shall not exceed the specified capability of the insulation to withstand high-voltage stress.

##### **B.2.2 System level immunity**

The test carried out in the laboratory refers to the EUT. The equipment level immunity does not assure the immunity of a system in all cases. For that reason a test on system level is advised which simulates the real installation. The simulated installation comprises protective devices (arrestors, varistors, shielded lines, etc.) and the real length and type of the interconnection lines.

This test is aimed at simulating as closely as possible the installation conditions in which the EUT or EUTs are intended to function later on.

In the case of the immunity under real installation conditions, higher voltage levels can be applied, but the energy involved will be limited by the protective devices according to their current-limiting characteristics.

The test is also intended to show that secondary effects produced by the protective devices (change of waveform, mode, amplitude of voltages or currents) do not cause unacceptable effects on the EUT.

#### **B.3 Installation classification**

**Class 0** Well-protected electrical environment, often within a special room

All incoming cables are provided with overvoltage (primary and secondary) protection. The units of the electronic equipment are interconnected by a well-designed earthing system, which is not essentially influenced by the power installation or lightning.

The electronic equipment has a dedicated power supply (see Table A.1).

Surge voltage may not exceed 25 V.

**Class 1** Partly protected electrical environment

All incoming cables to the room are provided with overvoltage (primary) protection. The units of the equipment are well interconnected by an earth line network, which is not essentially influenced by the power installation or lightning.

The electronic equipment has its power supply completely separated from the other equipment.

Switching operations can generate interference voltages within the room.

Surge voltage may not exceed 500 V.



- Class 2** Electrical environment where the cables are well separated, even at short runs  
The installation is earthed via a separate earth line to the earthing system of the power installation which can be essentially subjected to interference voltages generated by the installation itself or by lightning. The power supply to the electronic equipment is separated from other circuits, mostly by a special transformer for the power supply.  
Non-protected circuits are in the installation, but well separated and in restricted numbers.  
Surge voltages may not exceed 1 kV.
- Class 3** Electrical environment where power and signal cables run in parallel  
The installation is earthed to the common earthing system of the power installation which can be essentially subjected to interference voltages generated by the installation itself or by lightning.  
Current due to earth faults, switching operations and lightning in the power installation may generate interference voltages with relatively high amplitudes in the earthing system.  
Protected electronic equipment and less sensitive electric equipment are connected to the same power supply network. The interconnection cables can be partly outdoor cables, but close to the earthing network.  
Unsuppressed inductive loads are in the installation and usually there is no separation of the different field cables.  
Surge may not exceed 2 kV.
- Class 4** Electrical environment where the interconnections are running as outdoor cables along with power cables, and cables are used for both electronic and electric circuits  
The installation is connected to the earthing system of the power installation which can be subjected to interference voltages generated by the installation itself or by lightning.  
Currents in the kA range due to earth faults, switching operations and lightning in the power supply installation may generate interference voltages with relatively high amplitudes in the earthing system. The power supply network can be the same for both the electronic and the electric equipment. The interconnection cables are running as outdoor cables even to the high-voltage equipment.  
A special case of this environment is when the electronic equipment is connected to the telecommunication network within a densely populated area. There is no systematically constructed earthing network outside the electronic equipment, and the earthing system consists of pipes, cables etc. only.  
Surge voltage may not exceed 4 kV.
- Class 5** Electrical environment for electronic equipment connected to telecommunication cables and overhead power lines in a non-densely populated area  
All these cables and lines are provided with overvoltage (primary) protection. Outside the electronic equipment there is no widespread earthing system (exposed plant). The interference voltages due to earth faults (currents up to 10 kA) and lightning (currents up to 100 kA) can be extremely high.  
The requirements of this class are covered by the test level 4 (see Annex A).
- Class x** Special conditions specified in the product specifications

Examples for the installation of electronic equipment in different areas are given in Figure B.1, Figure B.2 and Figure B.3.



**B.3.1 Equipment level immunity of ports connected to the power supply network**

The minimum immunity level for connection to the public supply network is:

- Line-to-line coupling: 0,5 kV (test set-up see Figure 6 and Figure 8).
- Line-to-earth coupling: 1 kV (test set-up see Figure 7 and Figure 9).

**B.3.2 Equipment level immunity of ports connected to interconnection lines**

Surge tests on interconnection circuits are only required for external connections (outside of the cabinet/housing).

If it is possible to test at the system level (EUT with interconnection cables connected) it is not necessary to test at the equipment level (e.g. ports of the process-control/signal inputs/outputs) especially in cases where the shield of the interconnection cable is part of the protection measure. If the installation of the plant is carried out by someone other than the manufacturers of the equipment, the admissible voltage for the inputs/outputs (especially for the process interface) of the EUT should be specified.

The manufacturer should test his equipment on the basis of the specified test levels to confirm the equipment level immunity, e.g. with secondary protection at the ports of the EUT for a level of 0,5 kV. The user of the plant or those responsible for the installation should then apply measures (e.g. shielding, bonding, earthing protection) necessary to ensure that the interference voltage caused by, for example, lightning strikes does not exceed the chosen immunity level.

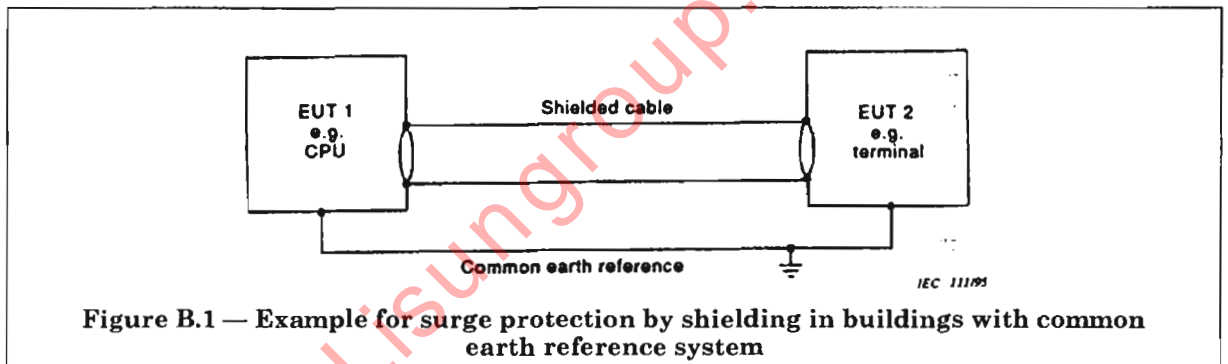

Figure B.1 — Example for surge protection by shielding in buildings with common earth reference system

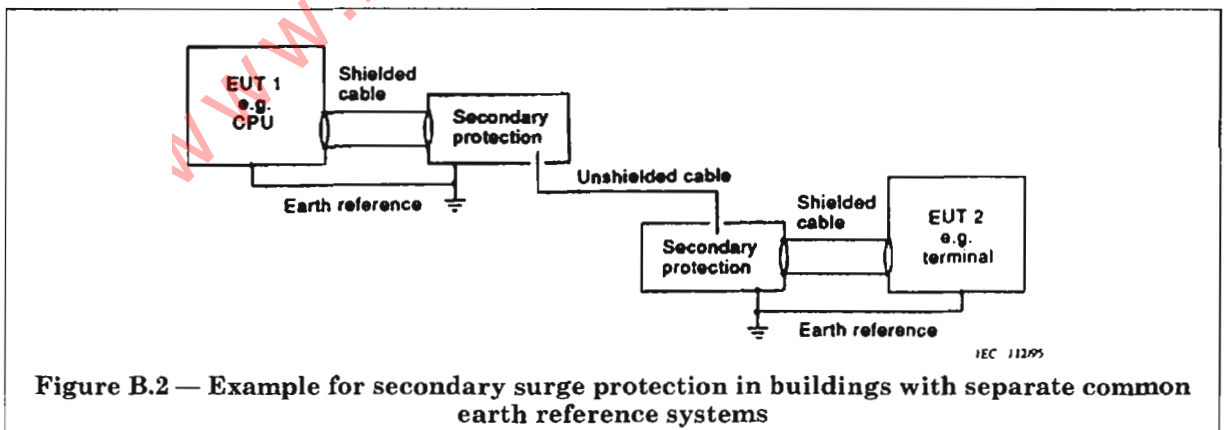

Figure B.2 — Example for secondary surge protection in buildings with separate common earth reference systems

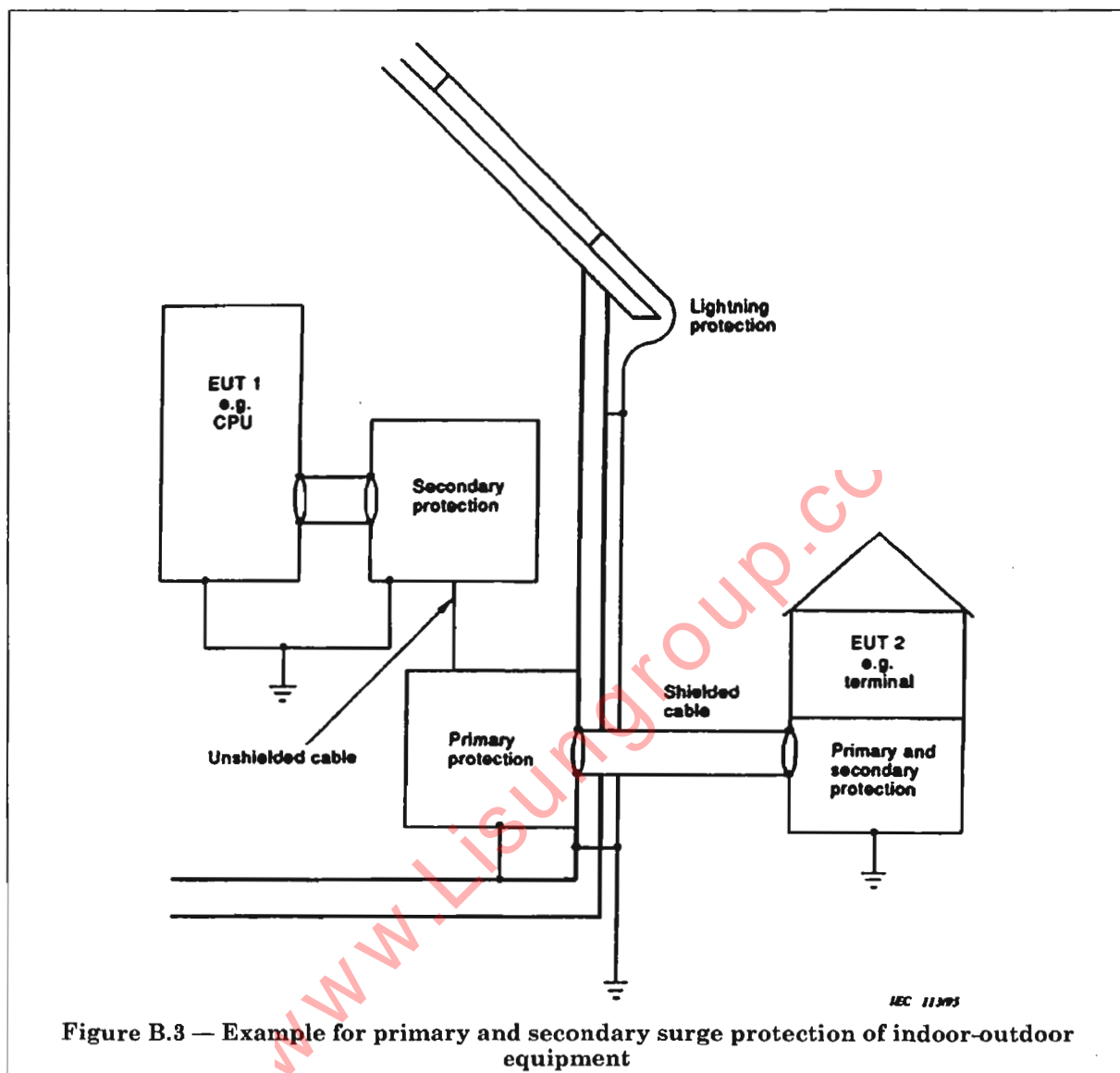

Figure B.3 — Example for primary and secondary surge protection of indoor-outdoor equipment

## Annex C (informative)

### Bibliography

- IEC 50(351):1975, *International Electrotechnical Vocabulary (IEV) — Chapter 351: Automatic control.*
- IEC 50(826):1982, *International Electrotechnical Vocabulary (IEV) — Chapter 826: Electrical installations of buildings.*
- IEC 1024-1:1990, *Protection of structures against lightning — Part 1: General principles.*
- IEC 1180-1:1992, *High-voltage test techniques for low-voltage equipment — Part 1: Definitions, test and procedure requirements.*
- CCITT Blue book, Volume IX:1988, Recommendation K.17: *Tests on power-fed repeaters using solid-state devices in order to check the arrangements for protection from external interference.*

**Annex ZA (normative)**

**Other international publications quoted in this standard with the references of the relevant European publications**

This European Standard incorporates by dated or undated reference, provisions from other publications. These normative references are cited at the appropriate places in the text and the publications are listed hereafter. For dated references, subsequent amendments to or revisions of any of these publications apply to this European Standard only when incorporated in it by amendment or revision. For undated references the latest edition of the publication referred to applies.

NOTE When the international publication has been modified by CENELEC common modifications, indicated by (mod), the relevant EN/HD applies.

IEC publication	Date	Title	EN/HD	Date
50(161)	1990	<i>International Electrotechnical Vocabulary (IEV) Chapter 161: Electromagnetic compatibility</i>	—	—
60-1	1989	<i>High-voltage test techniques — Part 1: General definitions and test requirements (corrigenda March 1990 + March 1992)</i>	HD 588.1 S1	1991
469-1	1987	<i>Pulse techniques and apparatus — Part 1: Pulse terms and definitions</i>	—	—

www.Lisungroup.com

BS EN  
61000-4-5: 1995  
IEC  
61000-4-5: 1995

## BSI — British Standards Institution

BSI is the independent national body responsible for preparing British Standards. It presents the UK view on standards in Europe and at the international level. It is incorporated by Royal Charter.

### Revisions

British Standards are updated by amendment or revision. Users of British Standards should make sure that they possess the latest amendments or editions.

It is the constant aim of BSI to improve the quality of our products and services. We would be grateful if anyone finding an inaccuracy or ambiguity while using this British Standard would inform the Secretary of the technical committee responsible, the identity of which can be found on the inside front cover. Tel: 020 8996 9000. Fax: 020 8996 7400.

BSI offers members an individual updating service called PLUS which ensures that subscribers automatically receive the latest editions of standards.

### Buying standards

Orders for all BSI, international and foreign standards publications should be addressed to Customer Services. Tel: 020 8996 9001. Fax: 020 8996 7001. Standards are also available from the BSI website at <http://www.bsi-global.com>.

In response to orders for international standards, it is BSI policy to supply the BSI implementation of those that have been published as British Standards, unless otherwise requested.

### Information on standards

BSI provides a wide range of information on national, European and international standards through its Library and its Technical Help to Exporters Service. Various BSI electronic information services are also available which give details on all its products and services. Contact the Information Centre. Tel: 020 8996 7111. Fax: 020 8996 7048.

Subscribing members of BSI are kept up to date with standards developments and receive substantial discounts on the purchase price of standards. For details of these and other benefits contact Membership Administration.

Tel: 020 8996 7002. Fax: 020 8996 7001. Further information about BSI is available on the BSI website at <http://www.bsi-global.com>.

### Copyright

Copyright subsists in all BSI publications. BSI also holds the copyright, in the UK, of the publications of the international standardization bodies. Except as permitted under the Copyright, Designs and Patents Act 1988 no extract may be reproduced, stored in a retrieval system or transmitted in any form or by any means – electronic, photocopying, recording or otherwise – without prior written permission from BSI.

This does not preclude the free use, in the course of implementing the standard, of necessary details such as symbols, and size, type or grade designations. If these details are to be used for any other purpose than implementation then the prior written permission of BSI must be obtained.

If permission is granted, the terms may include royalty payments or a licensing agreement. Details and advice can be obtained from the Copyright Manager. Tel: 020 8996 7070.

BSI  
389 Chiswick High Road  
London  
W4 4AL